



DS-9000-ST Series Hybrid DVR

DS-9600-ST/RT/XT Series NVR

DS-7700NI-SP Series NVR

USER'S MANUAL

Version 3.3

Hikvision® Network Digital Video Recorder User's Manual

This manual, as well as the software described in it, is furnished under license and may be used or copied only in accordance with the terms of such license. The content of this manual is furnished for informational use only, is subject to change without notice, and should not be construed as a commitment by Hikvision Digital Technology Co., Ltd. (Hikvision). Hikvision assumes no responsibility or liability for any errors or inaccuracies that may appear in the book.

Except as permitted by such license, no part of this publication may be reproduced, stored in a retrieval system, or transmitted, in any form or by any means, electronic, mechanical, recording, or otherwise, without the prior written permission of Hikvision.

HIKVISION MAKES NO WARRANTIES, EXPRESS OR IMPLIED, INCLUDING WITHOUT LIMITATION THE IMPLIED WARRANTIES OF MERCHANTABILITY AND FITNESS FOR A PARTICULAR PURPOSE, REGARDING THE HIKVISION SOFTWARE. HIKVISION DOES NOT WARRANT, GUARANTEE, OR MAKE ANY REPRESENTATIONS REGARDING THE USE OR THE RESULTS OF THE USE OF THE HIKVISION SOFTWARE IN TERMS OF ITS CORRECTNESS, ACCURACY, RELIABILITY, CURRENTNESS, OR OTHERWISE. THE ENTIRE RISK AS TO THE RESULTS AND PERFORMANCE OF THE HIKVISION SOFTWARE IS ASSUMED BY YOU. THE EXCLUSION OF IMPLIED WARRANTIES IS NOT PERMITTED BY SOME STATES. THE ABOVE EXCLUSION MAY NOT APPLY TO YOU.

IN NO EVENT WILL HIKVISION, ITS DIRECTORS, OFFICERS, EMPLOYEES, OR AGENTS BE LIABLE TO YOU FOR ANY CONSEQUENTIAL, INCIDENTAL, OR INDIRECT DAMAGES (INCLUDING DAMAGES FOR LOSS OF BUSINESS PROFITS, BUSINESS INTERRUPTION, LOSS OF BUSINESS INFORMATION, AND THE LIKE) ARISING OUT OF THE USE OR INABILITY TO USE THE HIKVISION SOFTWARE EVEN IF HIKVISION HAS BEEN ADVISED OF THE POSSIBILITY OF SUCH DAMAGES. BECAUSE SOME STATES DO NOT ALLOW THE EXCLUSION OR LIMITATION OF LIABILITY FOR CONSEQUENTIAL OR INCIDENTAL DAMAGES, THE ABOVE LIMITATIONS MAY NOT APPLY TO YOU.

Regulatory information

FCC information

FCC compliance: This equipment has been tested and found to comply with the limits for a digital device, pursuant to part 15 of the FCC Rules. These limits are designed to provide reasonable protection against harmful interference when the equipment is operated in a commercial environment. This equipment generates, uses, and can radiate radio frequency energy and, if not installed and used in accordance with the instruction manual, may cause harmful interference to radio communications. Operation of this equipment in a residential area is likely to cause harmful interference in which case the user will be required to correct the interference at his own expense.

FCC conditions

This device complies with part 15 of the FCC Rules. Operation is subject to the following two conditions:

1. This device may not cause harmful interference.
2. This device must accept any interference received, including interference that may cause undesired operation.

EU Conformity Statement



This product and - if applicable - the supplied accessories too are marked with "CE" and comply therefore with the applicable harmonized European standards listed under the Low Voltage Directive 2006/95/EC, the EMC Directive 2004/108/EC, the RoHS Directive 2011/65/EU.



2012/19/EU (WEEE directive): Products marked with this symbol cannot be disposed of as unsorted municipal waste in the European Union. For proper recycling, return this product to your local supplier upon the purchase of equivalent new equipment, or dispose of it at designated collection points. For more information see: www.recyclethis.info.



2006/66/EC (battery directive): This product contains a battery that cannot be disposed of as unsorted municipal waste in the European Union. See the product documentation for specific battery information. The battery is marked with this symbol, which may include lettering to indicate cadmium (Cd), lead (Pb), or mercury (Hg). For proper recycling, return the battery to your supplier or to a designated collection point. For more information see: www.recyclethis.info.

Industry Canada ICES-003 Compliance

This device meets the CAN ICES-3 (A)/NMB-3(A) standards requirements.

Preventive and Cautionary Tips

Before connecting and operating your DVR, please be advised of the following tips:

- Ensure unit is installed in a well-ventilated, dust-free environment.
- Unit is designed for indoor use only.
- Keep all liquids away from the DVR.
- Ensure environmental conditions meet factory specifications.
- Ensure unit is properly secured to a rack or shelf. Major shocks or jolts to the unit as a result of dropping it may cause damage to the sensitive electronics within the unit.
- Use the DVR in conjunction with an UPS if possible.
- Power down the unit before connecting and disconnecting accessories and peripherals.
- A factory recommended HDD should be used for this device.
- Improper use or replacement of the battery may result in hazard of explosion. Replace with the same or equivalent type only. Dispose of used batteries according to the instructions provided by the battery manufacturer.

CONTENTS

CHAPTER 1 Introduction	9
Overview.....	9
Product Features.....	10
Rear Panel.....	12
Product Application Diagram.....	17
Operating Your DVR.....	18
Using the Front Panel Controls.....	18
Using a USB Mouse.....	23
Using the Soft Keyboard.....	23
CHAPTER 2 Activating Your DVR	25
CHAPTER 3 Getting Started	44
Starting and Shutting Down Your DVR.....	44
Startup Your DVR.....	44
Shutdown Your DVR.....	44
Rebooting Your DVR.....	45
Locking Your DVR.....	45
Setting Date and Time.....	46
Checking the Status of Your DVR.....	47
CHAPTER 4 Live Feed	52
Watching a Live Feed.....	52
Understanding Live Feed Icons.....	52
Operating the Live Feed.....	53
Using Display Menu.....	59
Configuring Live Feed Displays.....	62
Setting Camera Order.....	64
Channel-Zero Encoding.....	65
CHAPTER 5 Record Settings	68
Configuring Settings for Recording.....	68
Configuring Recording Settings.....	68
Configuring Record Schedule.....	70
Configuring Holiday Settings.....	75
Configuring Settings for Capturing.....	76
Configuring Capture Quality Settings.....	76
Configuring Capture Schedule.....	76
CHAPTER 6 Playback	78

Playing Back a Recording.....	78
Understanding the Playback Interface.....	78
Searching for Recorded Files.....	79
Playing Back Recorded Files.....	80
Playing Back Multiple Channels.....	81
Smart Playback.....	82
Smart search.....	83
Playing Back Pictures.....	83
Playing Back Tags	84
Playing Back POS events.....	86
C H A P T E R 7 Backup.....	88
Backing up Video Clips	88
Selecting Video Clips.....	88
Backing up Video Clips	89
Backing up Recorded Files.....	92
C H A P T E R 8 System Configuration.....	94
Configuring Network Settings.....	94
Configuring General Settings	94
Configuring DDNS.....	95
Configuring SNMP	96
Configuring UPnP.....	97
Configuring More Settings	97
Managing User Accounts.....	99
Changing Password.....	99
Adding a New Remote/Local User	100
Changing the permission of User	101
Deleting a User	103
Editing a User	103
Switch User	103
Resetting Password.....	105
Reference: Password Strength Requirements	111
Configuring PTZ Cameras	115
Configuring Basic PTZ Settings	115
Customizing PTZ Presets, Patterns and Patrols	116
Configuring Alarms and Exceptions	118
Setting up Motion Detection.....	118

Configuring Alarm Inputs.....	121
Configuring Alarm Outputs.....	122
Configuring Exceptions	123
Configuring E-mail Settings	125
Configuring Hot Spare Settings	126
To setup hot spare settings:	126
Configuring POS (Point of Sale) Settings.....	127
CHAPTER 9 Camera Management	135
Configuring Cameras.....	135
Adding and Removing IP Cameras	135
Adding and Removing Analog Cameras	139
IP cameras List Import and Export	140
PoE Information.....	141
Configuring Privacy Mask	142
Configuring Tamper-proof.....	142
Configuring Video Loss	144
Configuring OSD Settings.....	144
Configuring Video Quality Diagnosis.....	145
Configuring VCA.....	146
CHAPTER 10 RAID Configuration.....	148
Configuring Array and Virtual Disk	148
One-touch Configuration	148
Manually Creating Array and Virtual Disk.....	149
Rebuilding Array	152
Automatically Rebuilding Array	153
Manually Rebuilding Array	153
Repairing Virtual Disk	154
Deleting Array / Virtual Disk	155
Deleting the Virtual Disk	155
Deleting the Array.....	155
Migrating and Expanding	156
Upgrading Firmware	158
CHAPTER 11 Disk Management.....	160
Managing Disks	160
Checking Disk Status.....	160
Setting Network HDD.....	160

Formatting Disk.....	162
Enabling HDD Overwrite.....	162
Enabling HDD Sleeping mode.....	163
Enabling eSATA Auto Archive.....	163
Managing eSATA	163
Configuring Quota Mode.....	164
Managing HDD Group.....	164
Disk Clone	166
HDD Detect	167
S.M.A.R.T.....	167
Bad Sector Detection.....	167
Managing Files	169
Searching for Recorded Files.....	169
Searching for Event Files.....	170
Searching for Captured Picture.....	171
Searching for POS event files.....	172
Locking and Unlocking Recorded Files	176
CHAPTER 12 DVR Management.....	177
Managing System.....	177
Upgrading the System Firmware	177
Restoring Default Settings	178
Exporting & Importing Configuration	180
Viewing System Logs	181
Network detection.....	183

CHAPTER 1 Introduction

Overview

Thank you for your purchase of DS-7700NI-SP/9000/9600 Series Hybrid Digital Video Recorder (HDVR)/NVR. To get detailed information about the HDVR/NVR, please read through the Installation's Manual and this User's Manual thoroughly.

The DS-7700NI-SP/9000/9600 series HDVR/NVR is a new generation product developed by HIKVISION. Built on an embedded platform and combining the latest advanced H.264 video encoding and decoding technologies, the DS-7700NI-SP/9000/9600 series HDVR/NVR contains the perfect combination of rock-solid reliability and high performance.



Figure 1 DS-9000/9600 Series HDVR/NVR



Figure 2 DS-9600NI-XT NVR



Figure 3 DS-7700NI-SP Series NVR

Product Features

Compression

- Connecting the network cameras, network dome and DVS.
- H.264 video compression with high reliability and superior definition.
- Each channel supports dual-stream.
- Up to 64 network cameras can be added.
- Independent configuration for each channel, including resolution, frame rate, bit rate, image quality, etc.
- The video input/output quality is configurable.
- Each channel supports two kinds of compression parameters, the continuous and event, which can be configured locally and remotely.
- Encoding for both audio/video composite stream and video stream; audio and video synchronization during composite stream encoding.
- Support watermark.

Local Monitoring

- Simultaneous HDMI, VGA and CVBS outputs.
- HDMI output and VGA output at up to 1920*1080P resolution.
- 1/4/6/8/9/16 –division live view is supported, and the display sequence of screens is adjustable.
- Live view screen can be switched in group, and manual switch and automatic cycle live view is also provided, the interval of automatic cycle can be adjusted.
- The selected live view channel can be shielded.
- Motion detection, tamper-proof, video exception alert and video loss alert functions.
- Manual video quality detection and handling.
- Privacy mask.
- Several PTZ protocols supported; PTZ preset, patrol and pattern.
- Zooming in by clicking the mouse and PTZ tracing by dragging mouse.

HDD Management

- Up to 16 disks (8 SATA hard disks and 8 network disks) and 1 eSATA disk can be connected.
- Each SATA hard disks and network disks with a maximum of 4 TB storage capacity and eSATA with less than 2 TB capacity.
- Support eSATA disk for recording or backup.
- HDD group management.
- HDD quota management; different capacity can be assigned to different channel.
- Support S.M.A.R.T and bad sector detection.

Recording, Capture and playback

- Holiday recording schedule configuration.
- Continuous and event video encoding parameters.
- 8 recording periods with separated recording types configurable.
- Pre-record and post-record for alarm, motion detection for recording, and pre-record time for schedule.
- Searching record files and captured pictures by events (alarm input/motion detection).

- Customization tags, searching and playing back by tags.
- Locking and unlocking record files.
- Searching and playing back record files by channel number, recording type, start time, end time, etc.
- Smart search for the motion event when playing back.
- Zooming in when playback.
- Reverse playback for multi-channel.
- Supports pause, speed up, speed down, skip forward, and skip backward when playback, locating by dragging the mouse.
- Up to 16-ch synchronous playback.
- Smart playback feature.
- Continuous capture of video images and playback of captured pictures.
- Support select main stream, sub stream or transcoded stream as recording stream. (transcoded stream only for NVR)

Backup

- Export video data by USB, or eSATA device.
- Export video clips when playback.
- Management and maintenance of backup devices.
- Automatic backup by eSATA devices.
- Disk clone by eSATA devices.

Alarm and Exception

- Alarm for Video loss, Motion detection, Tampering, HDD Full, HDD Error, Network Disconnected, IP Conflicted, Illegal Login, Video Signal Exception, Input/Output Video Standard Mismatch, Recording/Capture Exception, etc.
- Alarm triggers full screen monitoring, audible warning, notifying surveillance center, sending email and alarm output.
- Automatic restore when system is abnormal.
- Support push alarm notification

Other Local Functions

- Users can operate device by front panel, mouse, remote control, and control keyboard.
- Three-level user management; admin user can create many operating accounts and define their operating permissions, which includes the limit to access any channel.
- Operation, alarm exceptions and information log recording and searching.
- Import and export device configuration information.

Network

- 2 self-adaptive 10M/100M/1000M network interfaces(1 network interface for DS-7700NI-SP), and various working mode is configurable: multi-address, load balance, network fault tolerance, etc.
- IPv6 is supported.
- TCP/IP protocol, DHCP, DNS, DDNS, NTP, SADP, SMTP, SNMP, UPnP, NFS, and iSCSI are supported.
- TCP, UDP and RTP for unicast.
- Auto/manual port mapping and automatically discovered by UPnP™.

- Remote web browser access by HTTPS ensures high security.
- Remote search, playback, download, locking and unlocking the record files, and downloading files broken transfer resume.
- Remote parameters setup; remote import/export of device parameters.
- Remote viewing of the device status, system logs and alarm status.
- Remote keyboard operation.
- Remote locking and unlocking of control panel and mouse.
- Remote HDD formatting and program upgrading.
- Remote system restart and shutdown.
- Alarm and exception information can be sent to the remote host.
- Remotely start/stop recording.
- Remotely start/stop alarm output.
- Upgrade by remote FTP server is supported.
- Remote PTZ control.
- Remote JPEG capture.
- Two-way voice talk and voice broadcasting.
- Embedded WEB server.
- Support N+1 hot spare function (NVR and H-DVR support this function).
- Support ANR(Automatic Network Replenishment) technology
- Support Virtual Host function.

Development Support

- SDK for Windows and Linux system.
- Source code of application software for demo.
- Development support and training for application system.

Rear Panel

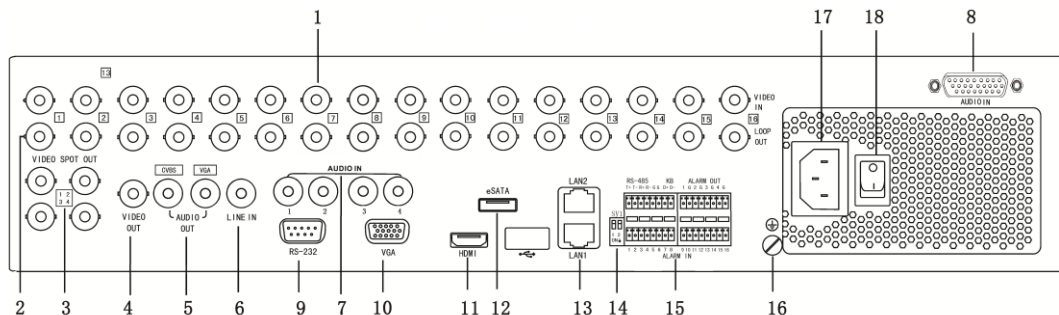

Figure 4 DS-9100/9000HFI-ST

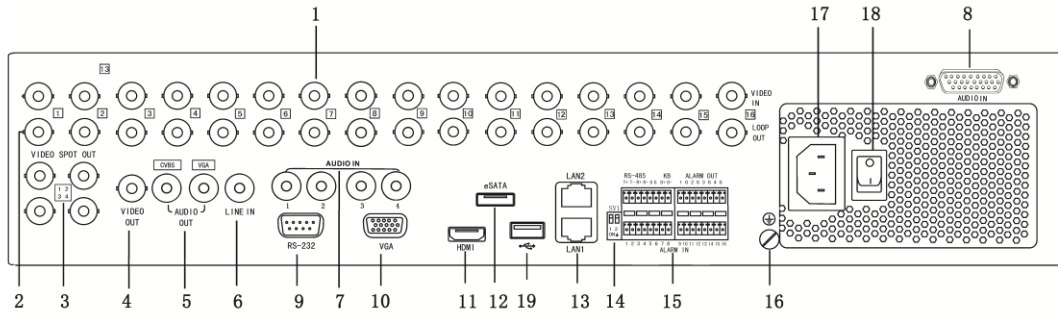

Figure 5 DS-9000HWI-ST & DS-9000HFI-RT

No.	Item	Description
1	VIDEO IN	BNC connector for analog video input.
2	LOOP OUT	BNC connectors for video loop output.
3	VIDEO SPOT OUT	BNC connectors for video output.
4	VIDEO OUT	BNC connector for video output. 1. When both HDMI and VGA are connected, it is used for live view only; 2. When either HDMI or VGA is connected, it is used as the spot video output for live view, playback, recording and PTZ controls; 3. When neither HDMI nor VGA is connected, it is used as the main video output for live view and menu operations.
5	AUDIO OUT	RCA connector for audio output.
6	LINE IN	RCA connector for voice talk.
7	AUDIO IN	RCA connector for audio input. (Audio 1-4)
8	AUDIO IN	DB26 connector for audio input. (Audio 5-16)
9	RS-232 Interface	Connector for RS-232 devices.
10	VGA	DB9 connector for VGA output. Display local video output and menu.
11	HDMI	HDMI video output connector.
12	eSATA	Connects external SATA HDD, CD/DVD-RM.
13	LAN Interface	Connector for LAN (Local Area Network).
14	Termination Switch	RS-485 termination switch. Up position is not terminated. Down position is terminated with 120Ω resistance.
15	RS-485 Interface	Connector for RS-485 devices. T+ and T- pin connects to R+ and R- pin of PTZ receiver respectively.
	Controller Port	D+, D- pin connects to Ta, Tb pin of controller. For cascading devices, the first device's D+, D- pin should be connected with the D+, D- pin of the next device.
	ALARM IN	Connector for alarm input.
	ALARM OUT	Connector for alarm output.
16	GROUND	Ground (needs to be connected when device starts up).
17	AC 100V~240V	AC 100V~240V power supply.
18	POWER	Switch for turning on/off the device.
19	USB	Universal Serial Bus (USB) ports for additional devices such as USB Hard Disk Drive (HDD).

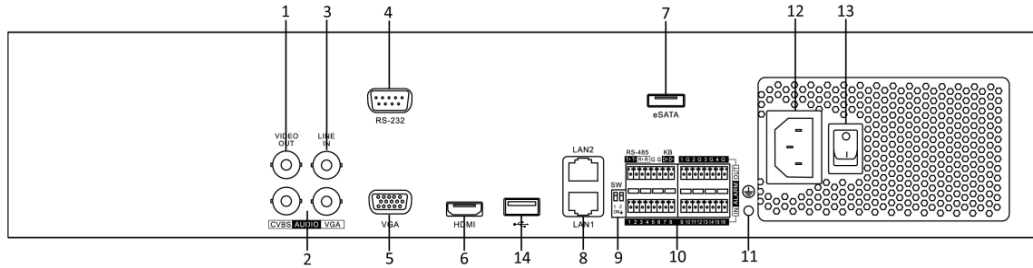

Figure 6 DS-9600NI-ST/RT

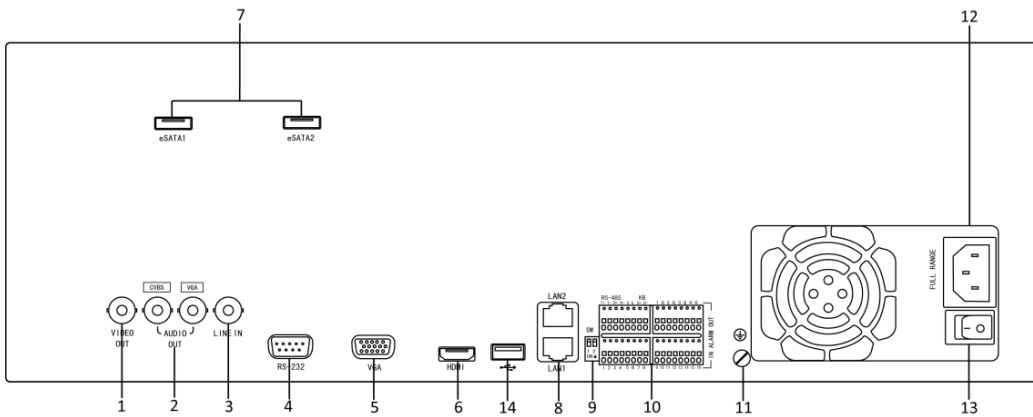

Figure 7 DS-9600NI-XT

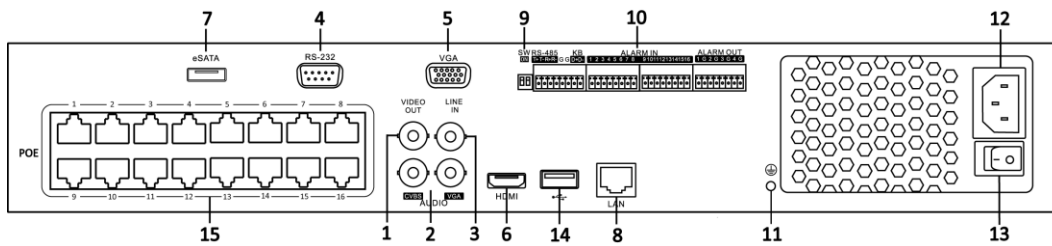

Figure 8 DS-7700NI-SP

No.	Item	Description
1	VIDEO OUT	BNC connector for video output.
2	AUDIO OUT	RCA connector for CVBS and VGA audio output.
3	LINE IN	RCA connector for audio output.
4	RS-232 Interface	Connector for RS-232 devices.
5	VGA	DB9 connector for VGA output. Display local video output and menu.
6	HDMI	HDMI video output connector.
7	eSATA	Connects external SATA HDD, CD/DVD-RM.
8	LAN Interface	Connector for LAN (Local Area Network).
9	Termination Switch	RS-485 termination switch. Up position is not terminated. Down position is terminated with 120Ω resistance.
10	RS-485 Interface	Connector for RS-485 devices. T+ and T- pin connects to R+ and R- pin of PTZ receiver respectively.
	Controller Port	D+, D- pin connects to Ta, Tb pin of controller. For cascading devices, the first device's D+, D- pin should be connected with the D+, D- pin of the next device.
	ALARM IN	Connector for alarm input.
	ALARM OUT	Connector for alarm output.
11	GROUND	Ground (needs to be connected when device starts up).
12	AC 100V~240V	AC 100V~240V power supply.
13	POWER	Switch for turning on/off the device.
14	USB interface	Universal Serial Bus(USB) ports for additional devices such as USB mouse and USB Hard Disk Drive(HDD).
15	Network Interfaces with POE function	Network interface for the cameras and to provide power over Ethernet.(DS-7700NI-SP POE NVR only)

Product Application Diagram

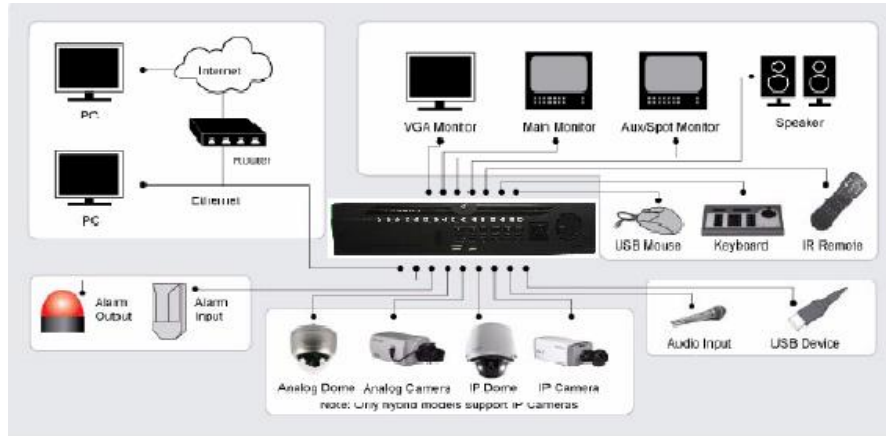

Figure 9 Product Application Diagram

Note:

DS-9600NI-ST/ DS-9600NI-RT/DS-9600NI-XT/DS-7700NI-SP can only connect network cameras.

Operating Your DVR

There are numerous ways to navigate and operate your DVR. You may use the Front Panel Controls, the included IR (Infrared) Remote, a Mouse and the Soft Keyboard.

Using the Front Panel Controls

Your DVR/NVR comes with built-in front panel controls, as shown in the following figure:

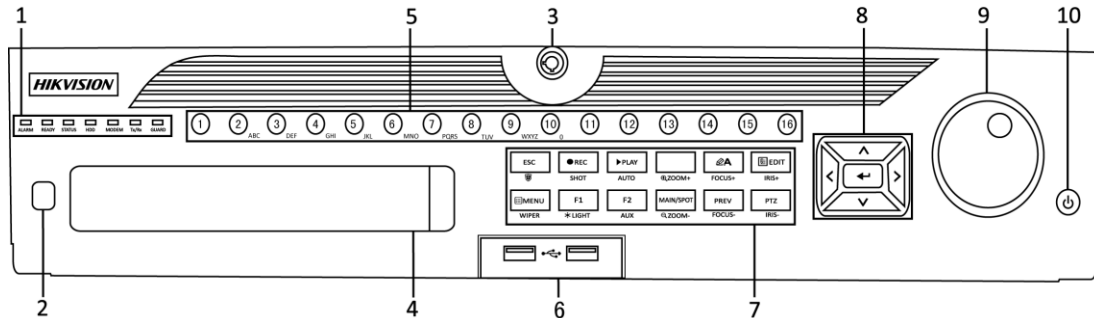

Figure 10 9000/9600 HDVR/NVR Front Panel Controls

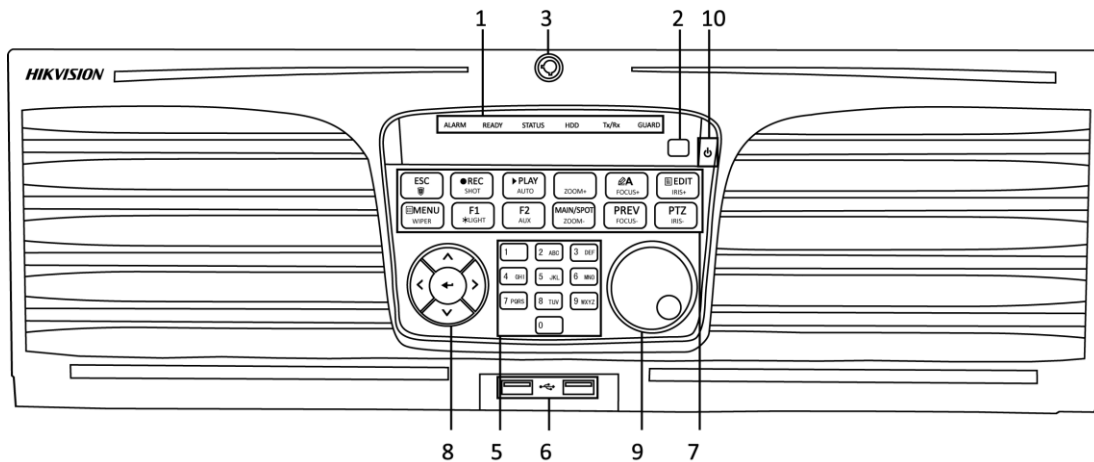

Figure 11 DS-9600NI-XT Front Panel Controls

The controls on the front panel include:

1. Status Indicators:

- **Alarm:** Alarm indicator turns red when a sensor alarm is detected.
- **Ready:** Ready indicator turns blue when DVR is functioning properly.
- **Status:** Status indicator turns blue when DVR is controlled by an IR remote. Indicator turns red when controlled by a keyboard and purple when IR remote and keyboard is used at the same time.
- **HDD:** HDD indicator blinks red when data is being read from or written to HDD.
- **Modem:** Reserved
- **TX/RX:** TX/RX indicator blinks blue when network connection is functioning properly.

- **Guard:** Guard indicator turns blue when the device is armed, off when the device is unarmed. The arm/disarm state can be initiated by pressing and holding on the ESC button for more than 3 seconds in Preview mode.
2. **IR Receiver:** Your DVR may also be controlled with the included IR remote control, shown in 2. Batteries (2 x AAA) must be installed before operation.
 3. **Front Panel Lock:** You can lock or unlock the panel by the key.
 4. **DVD-ROM:** Slot for DVR-ROM.
 5. **Alphanumeric Buttons:** Alphanumeric buttons used in various menus of the DVR. Some uses include:
 - Switching to the corresponding channel in Preview or PTZ Control mode.
 - Inputting numbers and characters in Edit mode.
 - Switching between different channels in Playback mode.
 6. **USB Ports:** Connects USB mouse or USE flash memory devices.
 7. **Control Buttons:**
 - **ESC Button:** The ESC button is used to escape to the previous menu and to arm/disarm the DVR in Preview mode.
 - **REC/SHOT Button:** The REC/SHOT button is used to enter the Quick Schedule Recording interface. If used when controlling a PTZ, pressing the REC/SHOT button and then a Numeric button will call a PTZ preset.
 - **PLAY/AUTO Button:** The PLAY/AUTO button is used to enter the Playback menu. It is also used to turn audio on/off in the Playback menu and auto scan in the PTZ Control menu.
 - **ZOOM+ Button:** The ZOOM+ button is used to zoom the PTZ camera in when in the PTZ Control menu.
 - **A/FOCUS+ Button:** The A/FOCUS+ button is used to adjust focus in the PTZ Control menu. It is also used to switch between input methods (upper and lowercase alphabet, symbols and numeric input). It can also be used to clear entire masked areas, such as in the Motion Detection and Privacy Mask menus.
 - **EDIT/IRIS+ Button:** The EDIT/IRIS+ button is used to edit text fields. When editing text fields, it will also function as a Backspace button to delete the character in front of the cursor. On checkbox fields, pressing the EDIT/IRIS+ button will tick the checkbox. In PTZ Control mode, the EDIT/IRIS+ button opens up the iris of the camera. In Playback mode, it can be used to generate video clips for backup.
 - **MENU/WIPER Button:** Pressing the MENU/WIPER button will return the user to the Main menu (after successful login). Pressing and holding the button for 5 seconds will turn off audible key beep. The MENU/WIPER button will also bring up Sensitivity Interface settings. In PTZ Control mode, the MENU/WIPER button will start wiper (if applicable).
 - **F1/LIGHT Button:** The F1/LIGHT button when used in a list field will select all items on the list. In PTZ Control mode, it will turn on/off PTZ light.
 - **F2/AUX Button:** The F2/AUX button is used to cycle through tab pages. It will also bring up the Channel & OSD Position settings.
 - **MAIN/SPOT/ZOOM- Button:** The MAIN/SPOT/ZOOM- button is used to switch to the control of spot output. In PTZ Control mode, it can be used to zoom the camera out.

- **PREV/FOCUS- Button:** The PREV/FOCUS- button is used to switch between single screen and multi-screen mode. In PTZ Control mode, it is used to adjust the focus in conjunction with the A/FOCUS+ button. It can also be used to select entire masked areas, such as in Motion Detection and Privacy Mask menus.
8. **Direction/Enter Buttons:**
- **Direction Buttons:** The Direction buttons are used to navigate between different fields and items in menus. In playback mode, the Up and Down button is used to fast-forward and rewind recorded video. The left and Right button will select the next and previous day of or pause the video. In Single Play mode, pressing the Enter button will advance the video by a single frame.
 - **Enter Button:** The Enter button is used to confirm selection in any of the menu modes. It can be used to tick checkbox fields. In Playback mode, it can be used to play or pause the video. In Single Play mode, pressing the Enter button will advance the video by a single frame.
9. **Jog Shuttle Control:** The Jog Shuttle control can be used to move the active selection in a menu. In the playback mode, the outer ring is used to speed up/slow down the video. The inner ring can be used to jump 30 seconds forward/backward in a video. In Preview mode, it can be used to cycle through different channels.
10. **Power Button:** Powers DVR on/off.

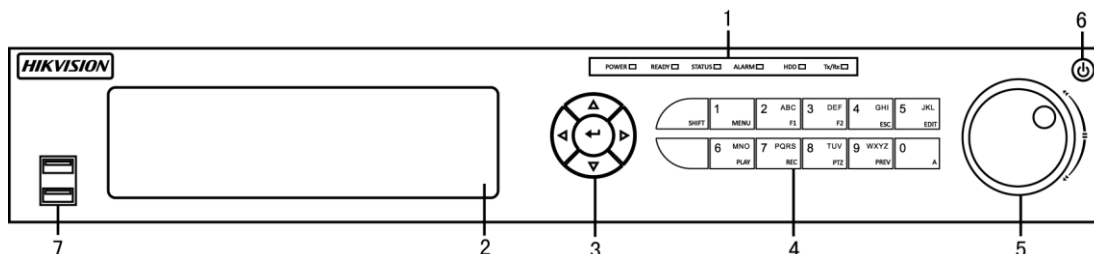

Figure 12 7700 NVR Front Panel Controls

The controls on the front panel include:

1. **Status Indicators:**

- **Alarm:** Alarm indicator turns red when a sensor alarm is detected.
- **Ready:** Ready indicator turns blue when DVR is functioning properly.
- **Status:** Status indicator turns blue when DVR is controlled by an IR remote. Indicator turns red when controlled by a keyboard and purple when IR remote and keyboard is used at the same time.
- **HDD:** HDD indicator blinks red when data is being read from or written to HDD.
- **Modem:** Reserved
- **TX/RX:** TX/RX indicator blinks blue when network connection is functioning properly.

2. **DVD-ROM:** Slot for DVR-ROM.

3. **Direction/Enter Buttons:**

- **Direction Buttons:** The Direction buttons are used to navigate between different fields and items in menus. In playback mode, the Up and Down button is used to

fast-forward and rewind recorded video. The left and Right button will select the next and previous day of or pause the video. In Single Play mode, pressing the Enter button will advance the video by a single frame.

- **Enter Button:** The Enter button is used to confirm selection in any of the menu modes. It can be used to tick checkbox fields. In Playback mode, it can be used to play or pause the video. In Single Play mode, pressing the Enter button will advance the video by a single frame.

4. Control Buttons:

- **1/MENU:** Enter numeral “1”; Access the main menu interface.
 - **2ABC/F1:** Enter numeral “2”; Enter letters “ABC”; The F1 button can be used to select all items on the list; In PTZ Control mode, the F1 button can be used to zoom out (zoom-) the PTZ camera; In live view or playback mode, the F1 button can be used to switch between main and spot video output.
 - **3DEF/F2:** Enter numeral “3”; Enter letters “DEF”; In PTZ Control mode, the F1 button can be used to zoom in (zoom+) the PTZ camera; The F2 button can be used to cycle through tab pages.
 - **4GHI/ESC:** Enter numeral “4”; Enter letters “GHI”; Exit and back to the previous menu.
 - **5JKL/EDIT:** Enter numeral “5”; Enter letters “JKL”; Delete characters before cursor; Select the checkbox and ON/OFF switch; Start/stop record clipping in playback.
 - **SHIFT:** Switch of compound keys between the numeric/letter input and functional control.
 - **6MNO/PLAY:** Enter numeral “6”; Enter letters “MNO”; In Playback mode, it is used for direct access to playback interface.
 - **7PQRS/REC:** Enter numeral “7”; Enter letters “PQRS”; Manual record, for direct access to manual record interface; manually enable/disable record.
 - **8TUV/PTZ:** Enter numeral “8”; Enter letters “TUV”; Access PTZ control interface.
 - **9WXYZ/PREV:** Enter numeral “9”; Enter letters “WXYZ”; Multi-camera display in live view; In Playback mode or Menu→Playback→Tag playback interface, this button can be used to delete the selected tag.
 - **0/A:** Enter numeral “0”; Switch between input methods (upper and lowercase alphabet, symbols and numeric input). In Playback mode, this button can be used to add the default tag.
5. **Jog Shuttle Control:** The Jog Shuttle control can be used to move the active selection in a menu. In the playback mode, the outer ring is used to speed up/slow down the video. The inner ring can be used to jump 30 seconds forward/backward in a video. In Preview mode, it can be used to cycle through different channels.
 6. **Power Button:** Powers DVR on/off.
 7. **USB Ports:** Connects USB mouse or USE flash memory devices.

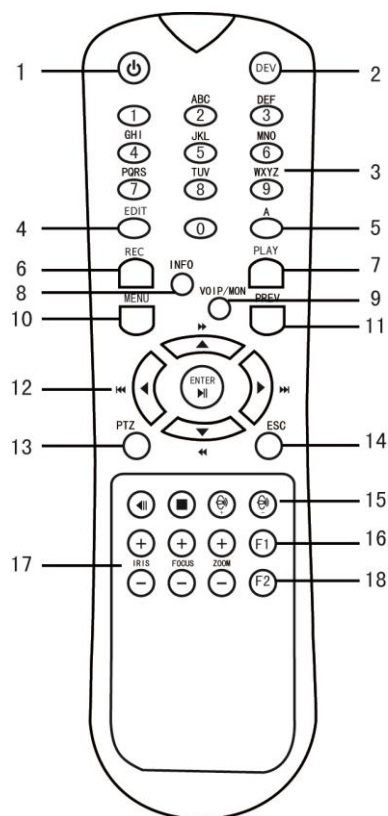

Figure 13 IR Remote Control

The keys on the remote control closely resemble the ones found on the front panel. Referring to Figure 13 IR Remote Control, they include:

1. **POWER:** Turn on/off DVR.
2. **DEV:** Enable/Disable Remote Control.
3. **Alphanumeric:** Same as Alphanumeric buttons on front panel.
4. **EDIT:** Same as JKL/EDIT button on front panel.
5. **A:** Same as A/FOCUS+ button on front panel.
6. **REC:** Same as REC/SHOT button on front panel.
7. **PLAY:** Same as MNO/PLAY button on front panel.
8. **INFO:** Same as ZOOM+ button on front panel.
9. **VOIP:** Same as MAIN/SPOT/ZOOM- button on front panel.
10. **MENU:** Same as MENU/WIPER button on front panel.
11. **PREV:** Same as PREV/FOCUS- button on front panel.
12. **DIRECTION/ENTER Buttons:** Same as DIRECTION/ENTER buttons on front panel.
13. **PTZ:** Same as PTZ/IRIS- button on front panel.
14. **ESC:** Same as ESC button on front panel.
15. **RESERVED:** Reserved.
16. **F1:** Same as F1/LIGHT button on front panel.
17. **PTZ CONTROL Buttons:** Buttons to adjust the iris, focus and zoom of a PTZ camera.

18.F2 Button: Same as F2/AUX button on front panel.

Aim the remote control at the IR receiver located at the front of the unit to test operation. If there is no response:

1. Using the front control panel or the mouse, go into Menu > System Configuration > General > More Settings.
2. Check and remember DVR ID#. The default ID# is 255. This ID# is valid for all IR controls.
3. Press the DEV button on the remote.
4. Enter the DVR ID# from step 2.
5. Press the ENTER button on the remote control.

If the Status indicator on the front panel turns blue, the remote control is operating properly. If the Status indicator does not turn blue and there is still no response from the remote, please check the following:

1. Batteries are installed correctly and the polarities of the batteries are not reversed.
2. Batteries are fresh and not out of charge.
3. IR receiver is not obstructed.
4. No fluorescent lamp is used nearby.

Using a USB Mouse

A regular 3-button (Left/Right/Scroll-wheel) USB mouse can also be used with this DVR. To use a USB mouse:

1. Plug USB mouse into one of the USB ports on the front panel of the DVR.
2. The mouse should automatically be detected. If in a rare case that the mouse is not detected, please refer to the recommended device list from your provider.

The buttons on the mouse corresponds to:

1. Left Button:
 8. **Single-Click:** Select a component of a menu, such as a button or an input field. This is similar to pressing the ENTER button on the remote/front panel controls.
 9. **Double-Click:** Switch between single screen and multi-screen mode in Preview/Playback mode.
 10. **Click and Drag:** Clicking and dragging the Left mouse button can be used to control the pan/tilt of a PTZ camera as well as to vary the position of digital zoom area and camera OSD. It can also be used to set the alarm areas.
2. Right Button:
 11. **Single-Click:** Shows pop-up menu in preview interface. Exit to return to the previous menu.

Using the Soft Keyboard

When a mouse is used to perform task on the DVR, clicking on a text input field will bring up the Soft Keyboard, shown in Figure 14 Soft Keyboard.



Figure 14 Soft Keyboard

The buttons on the soft keyboard represents:



Switch to Uppercase: Switch to uppercase input.



Symbols/Number: Switch to symbols and numbers input.



Backspace: Delete the character in front of the cursor.



Enter: Confirm selection.

CHAPTER 2

Activating Your DVR

To ensure the highest level of protection, Hikvision has launched a login procedure that requires users to create a new password for the **admin** account upon the first login to all devices. The password must contain 8 to 16 characters, combining numbers, lowercase letters, uppercase letters, and special characters. At least two types of the above-mentioned characters are required to activate the device. The system will check the password strength; "Risky" passwords will not be accepted.

Device Firmware with Secure Activation

Device Type	Model Number	Firmware Version
Value Series IP Camera	DS-2CD2xxx	V5.3.0
Smart Series IP Camera	DS-2CD4xxx	V5.3.0
NVR/Hybrid	DS-9016HWI-ST DS-96xxNI-ST DS-7716NI-SP/16	V3.1.5
Plug-n-Play NVR	DS-76xxNI-EI(E2)/P	V3.1.0
Turbo DVR	DS-72xxHGHI-SH DS-73xxHQHI-SH DS-90xxHQHI-SH	V3.1.6
Super NVR	DS-96128NI-E24/H DS-96256NI-E24/H	TBD

NOTE: DVRs/NVRs starting with the latest firmware (see chart, above) WILL NO LONGER HAVE A DEFAULT PASSWORD. The user must activate the NVR by creating a password for the **admin** account, which can be done in one of four ways:

- **Local Activation**

1. Power on the DVR/NVR.
 - An activation message will appear on the screen prompting the user to activate the device (**Figure 15**).
 - The username field will be greyed-out with the username set to **admin**.
2. Type in a password of your choosing (see "Password Strength Levels" table on page 37 for guidelines).

- The password strength will be displayed, accompanied by a color indicator*:
 - Level 0–*Risky* (red indicator): Not acceptable
 - Level 1–*Weak* (red indicator): Acceptable
 - Level 2–*Fair* (orange indicator): Acceptable
 - Level 3–*Strong* (blue indicator): Acceptable
 - Activation will not be allowed unless the password is of acceptable strength (**Figure 18, Figure 19, and Figure 20**).
3. Retype the password into the “Confirm Password” field.

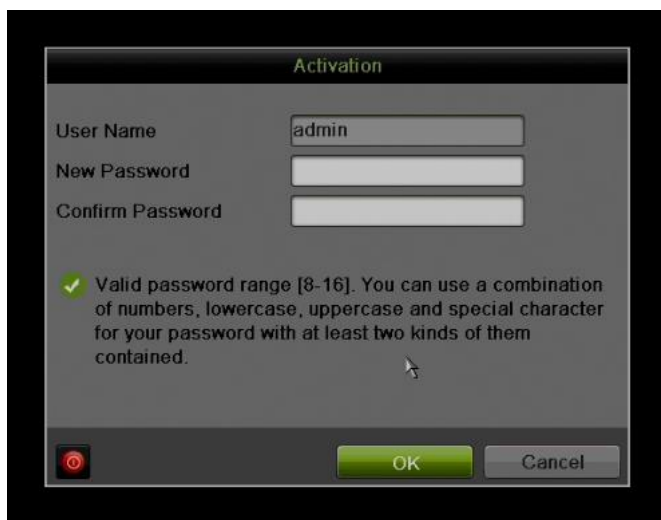
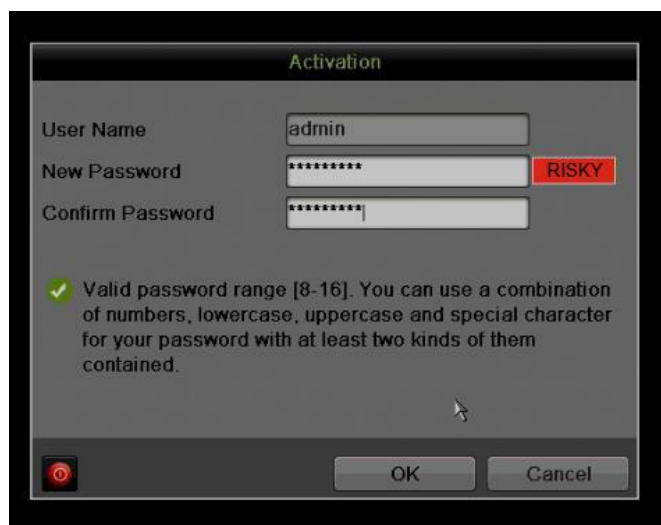

Figure 15 Activation Window



* **NOTE:** The strength level indicator colors can vary by activation process, model number, and device type.

Figure 16 Risky (Inadequate) Strength Password



Figure 17 Invalid Password Message

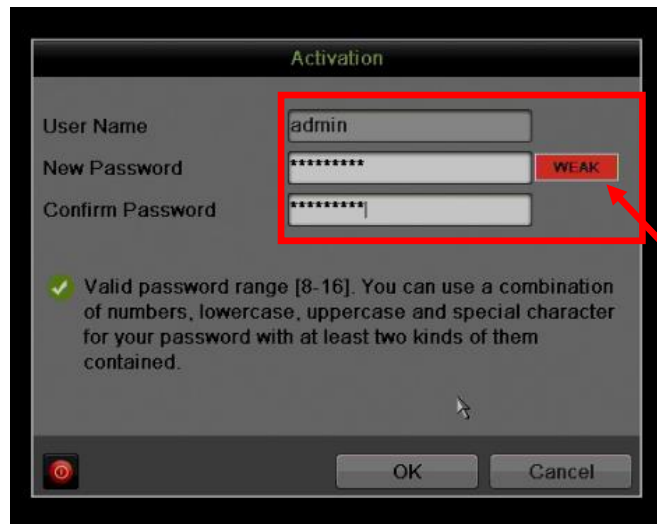

Figure 18 Weak (Adequate) Password Strength



Figure 19 Fair (Adequate) Password Strength

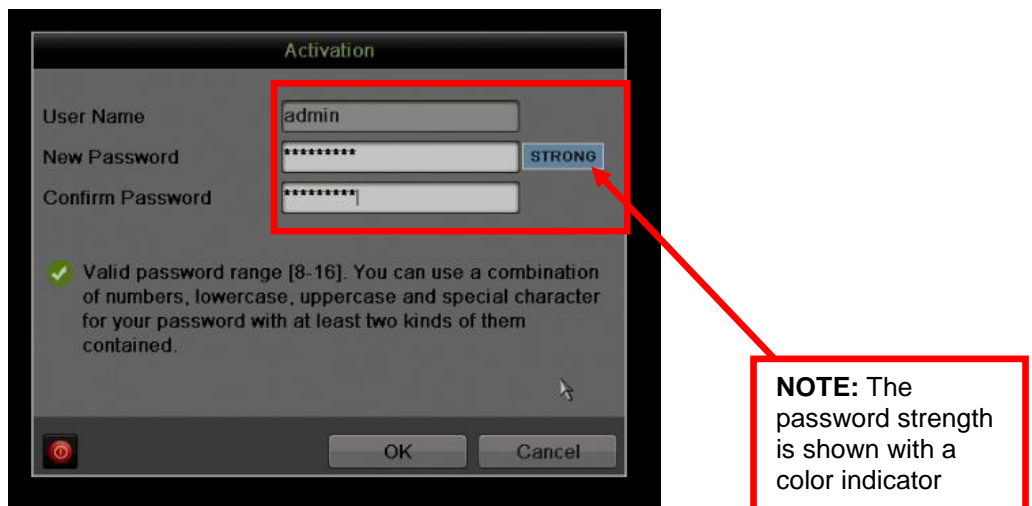

Figure 20 Strong Password Strength

3. After an acceptable password has been created, a confirmation message will appear on the screen (**Figure 21**).
4. Press the **OK** button to proceed.

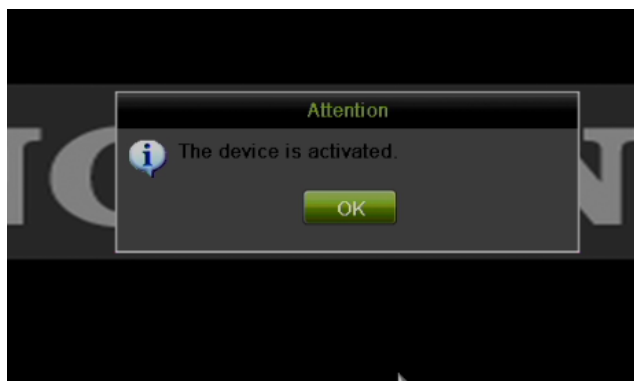

Figure 21 Activation Confirmation Message

- **SADP Software Activation (v2.2.3.5 or higher)**
 1. Launch the new version of the SADP software (v2.2.3.5).
 - The software will display all Hikvision devices on the network.
 - A new field called "Security" will display whether the DVR/NVR is active or not (**Figure 22**).
 2. If the DVR/NVR is "Inactive," highlight the DVR/NVR and enter a new password into the "New Password" field on the bottom right of the screen (**Figure 23**). See "Password Strength Levels" table on page 37 for guidelines.
 - The password strength will be displayed, accompanied by a color indicator:
 - Level 0—*Risky* (no indicator): Not acceptable
 - Level 1—*Weak* (pink indicator): Acceptable
 - Level 2—*Medium* (yellow indicator): Acceptable
 - Level 3—*Strong* (green indicator): Acceptable
 - Bar length indicates strength level.
 - Activation will not be allowed unless the password is of acceptable strength (**Figure 25, Figure 26, Figure 27**). If the password is unacceptable strength ("Risky," **Figure 9**), a warning box will be displayed (**Figure 10**).
 3. Retype the password into the "Confirm Password" field.
 4. After the password has been entered and confirmed, press the **OK** button to display the pop-up confirmation window (**Figure 14**).
 5. Press the "X" in the top right corner of the pop-up confirmation window to dismiss the window.

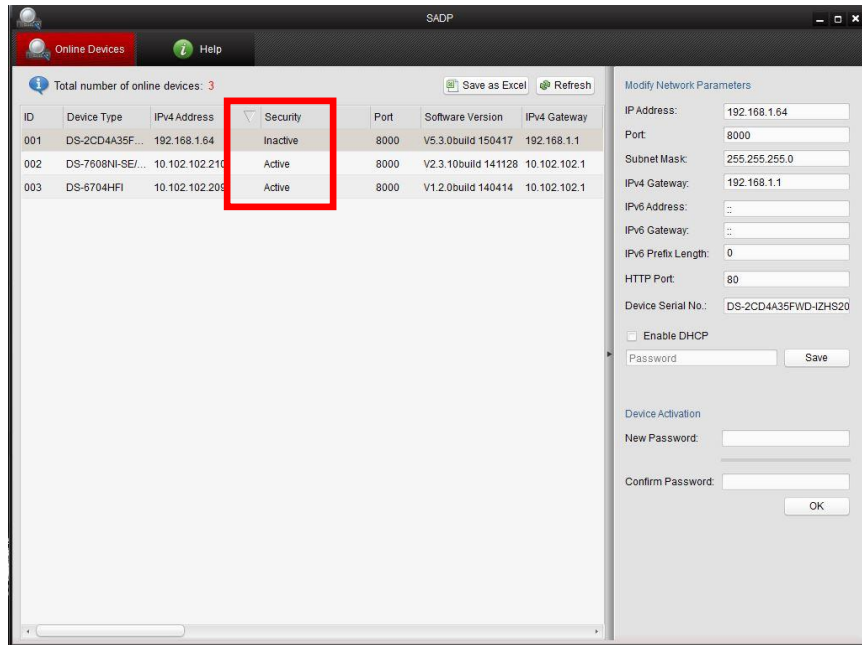

Figure 22 Security Field

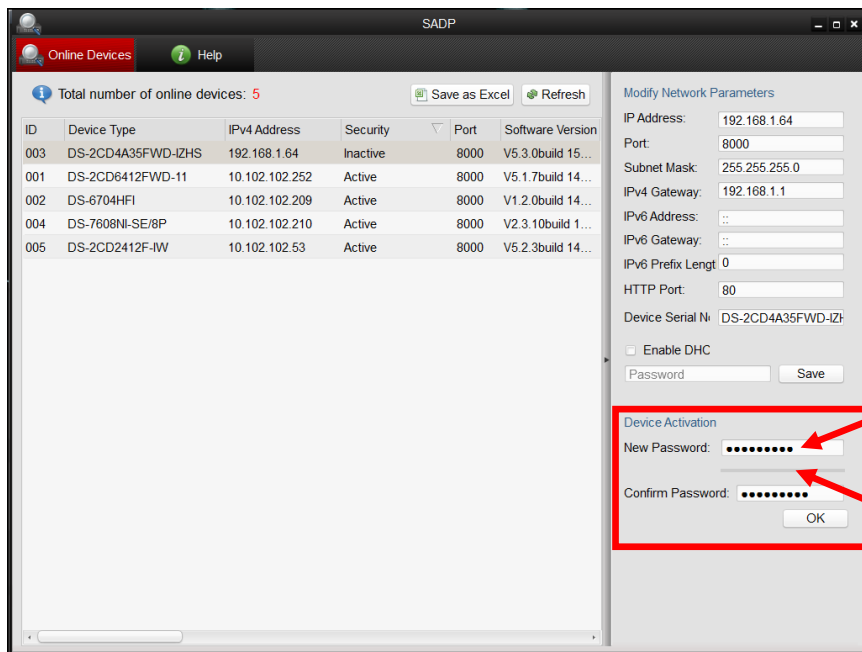

Figure 23 Password Field with "Risky" Unacceptable Password

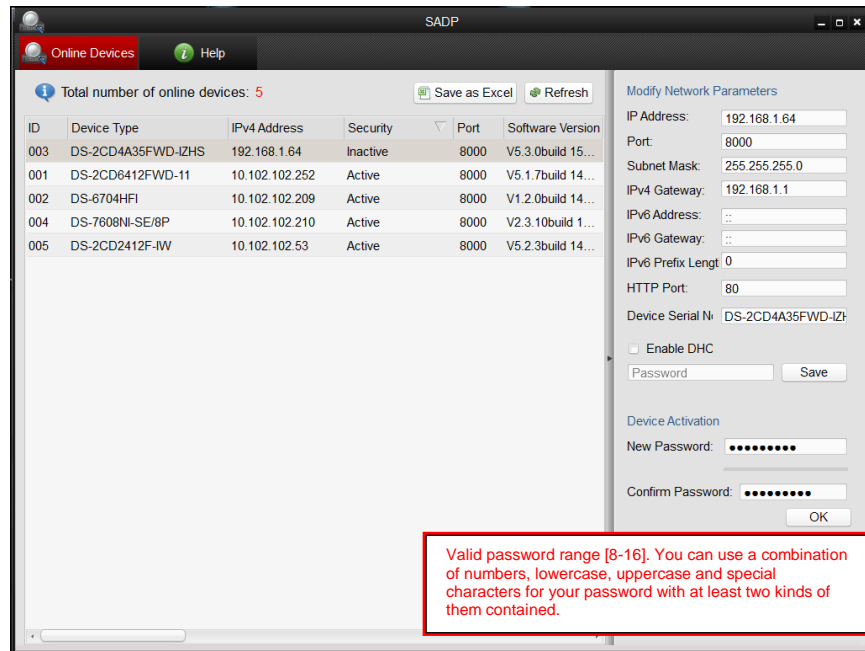

Figure 24 “Risky” Unacceptable Password Warning Message

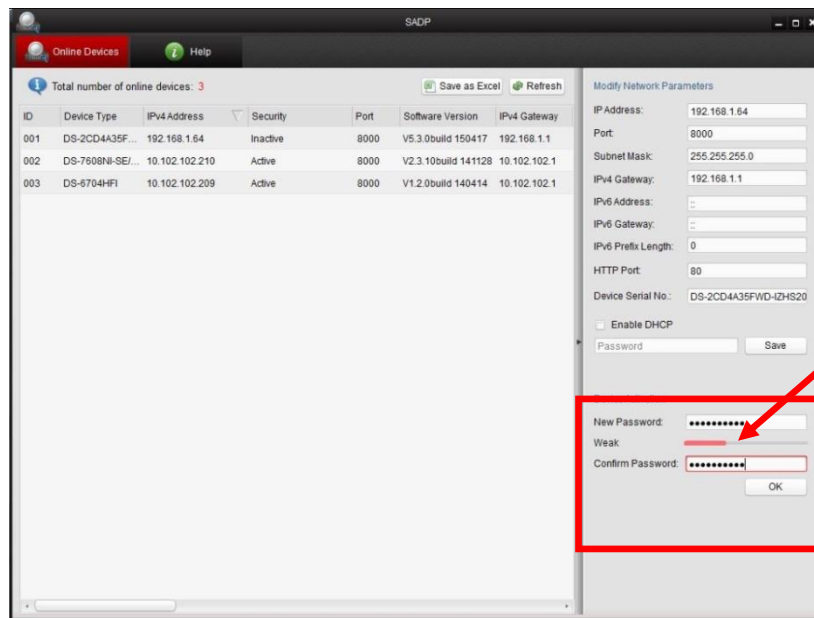

Figure 25 Password Field with Weak Strength Password

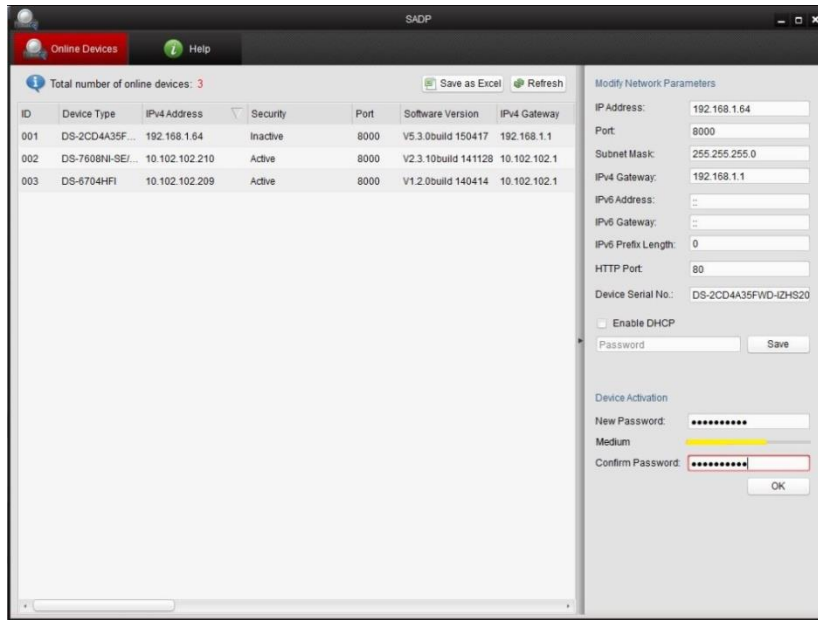

Figure 26 Password Field with Medium Strength Password

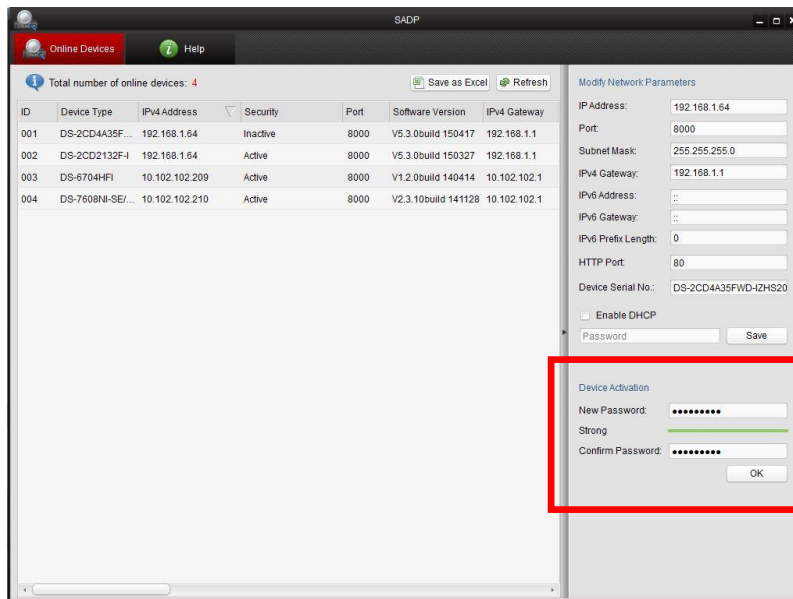

Figure 27 Password Field with Strong Strength Bar

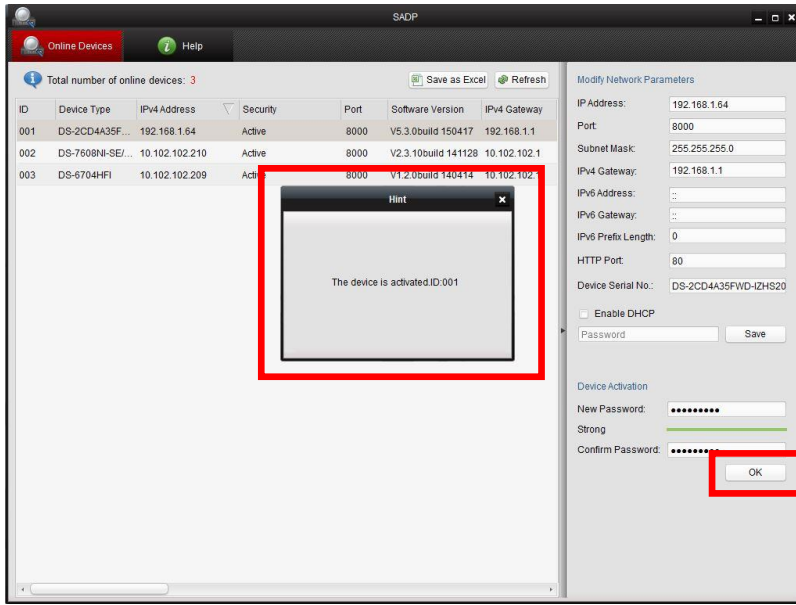

Figure 28 Confirmation Window

- **iVMS-4200 Windows Client Software (v2.3.1.3 or higher) Activation**
 1. Launch the iVMS-4200 software.
 2. Go to **Control Panel**→**Device Management (Figure 15)**.
 - On the bottom of the screen in the Online Devices section the screen will display all Hikvision devices on the network.
 - A new field called “Security” will display whether the DVR/NVR is active or not (**Figure 16**).
 3. If the DVR/NVR is “Inactive,” highlight the DVR/NVR and press the **Activate** button (**Figure 16**) to display the “Activation” window (**Figure 17**).
 4. Enter a new password into the “Password” field (**Figure 17**). See “Password Strength Levels” table on page 37 for guidelines.
 - The password strength will be displayed, accompanied by a color indicator:
 - Level 0—*Risky* (no indicator): Not acceptable
 - Level 1—*Weak* (pink indicator): Acceptable
 - Level 2—*Medium* (yellow indicator): Acceptable
 - Level 3—*Strong* (green indicator): Acceptable
 - Bar length indicates strength level.
 - Activation will be allowed if the password is of acceptable strength (**Figures 19, 20, and 21**).
 - If the password is of unacceptable strength (“Risky,” **Figure 17**), a warning box will be displayed (**Figure 18**) explaining the requirements for an acceptable password.
 5. Retype the password into the “Confirm Password” field.
 6. After the password has been entered and confirmed, press the **OK** button.
 - The DVR’s/NVR’s status will change to “Active” (**Figure 19**).

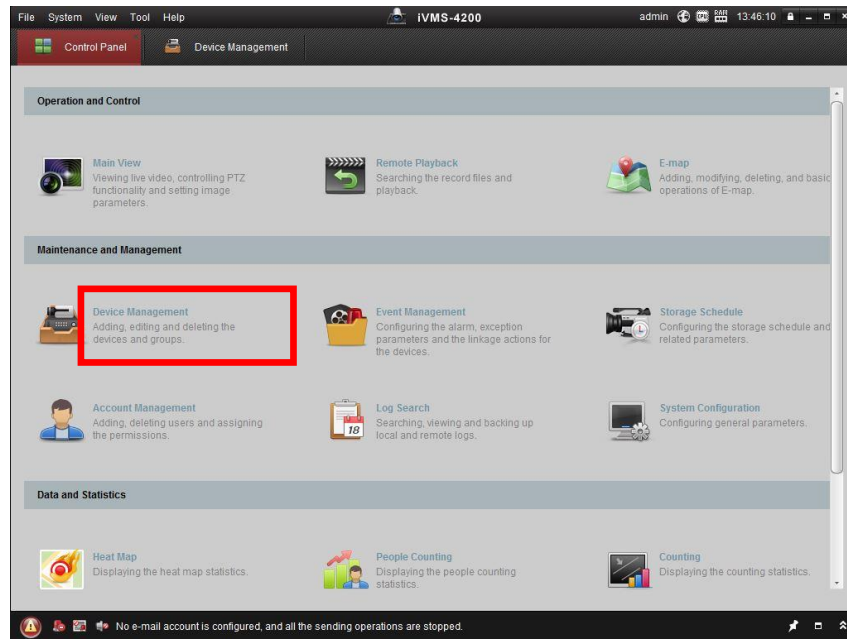

Figure 29 iVMS 4200 Control Panel

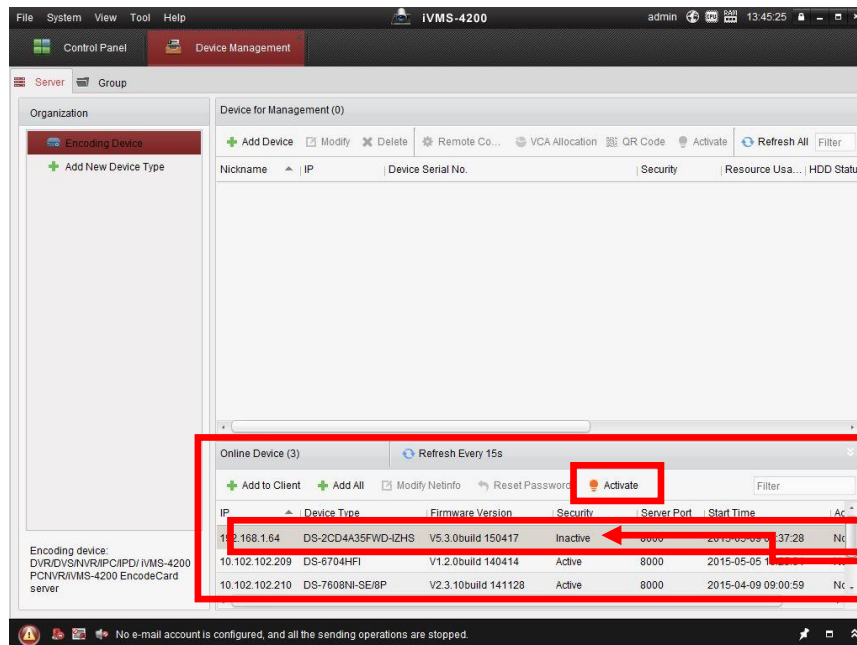

Figure 30 Inactive DVR/NVR Status

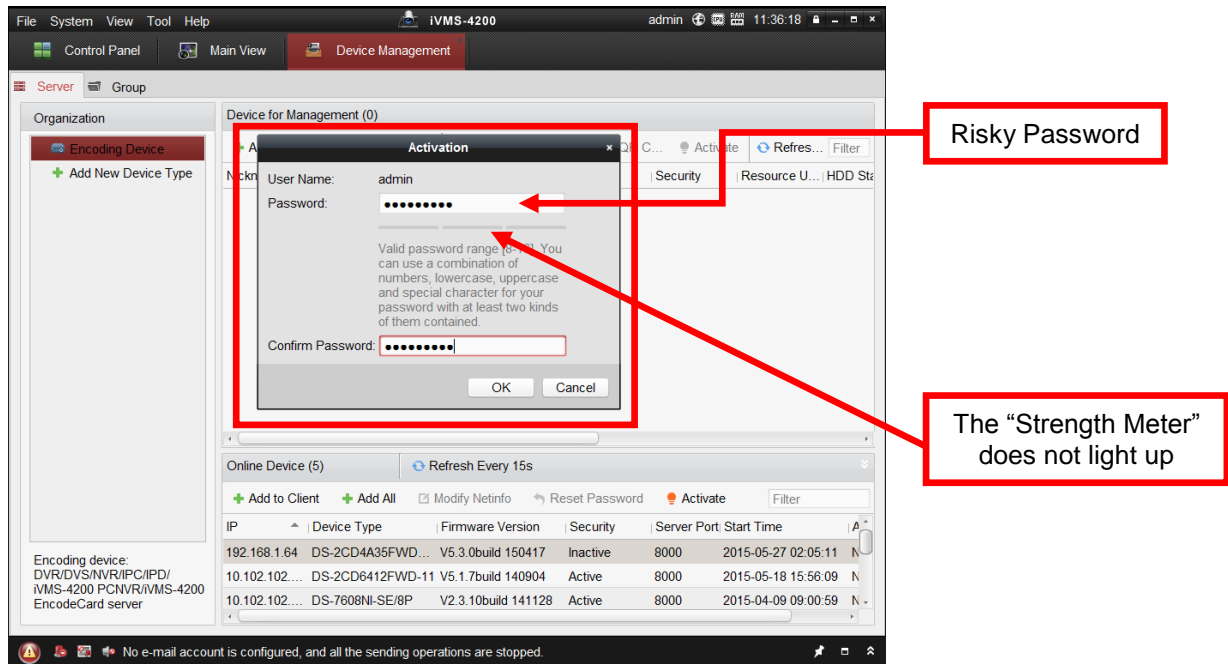

Figure 31 Activation Window with Risky (Inadequate) Password Strength

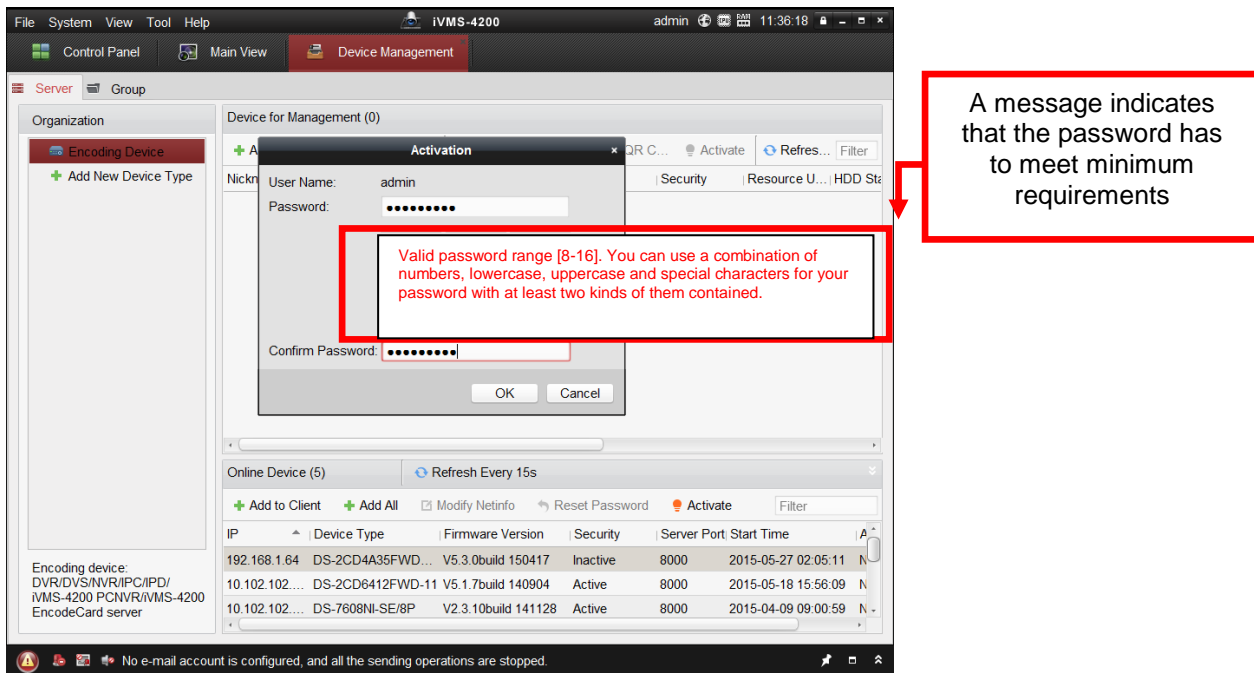

Figure 32 Risky (Inadequate) Password Strength Warning Message

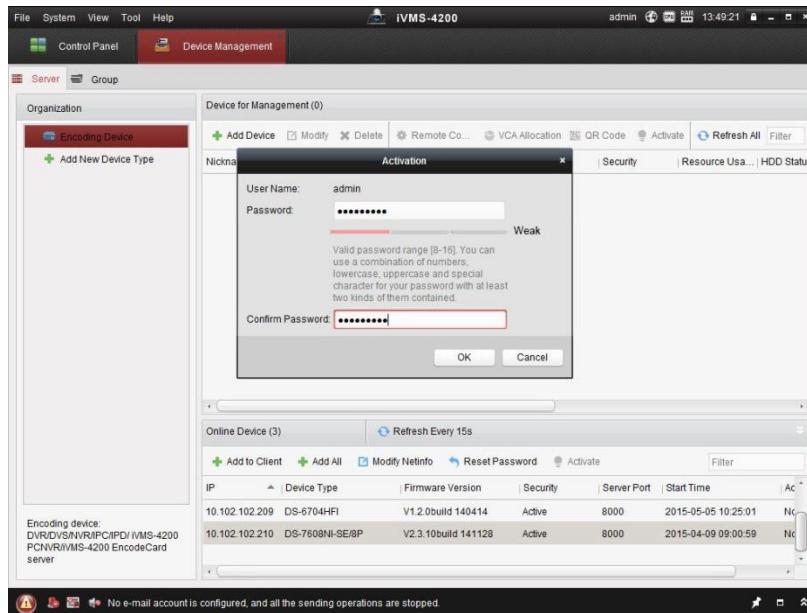

Figure 33 Weak (Adequate) Password Strength

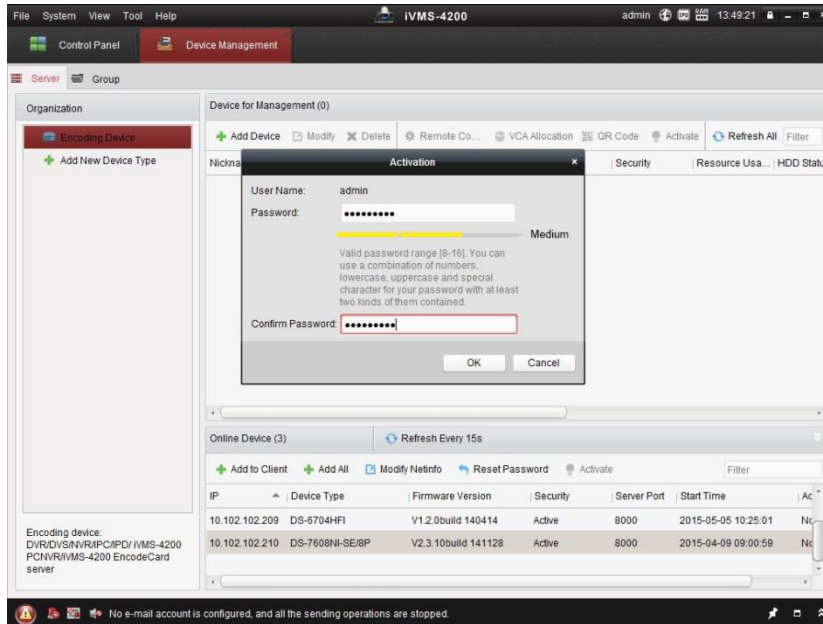

Figure 34 Medium (Adequate) Password Strength

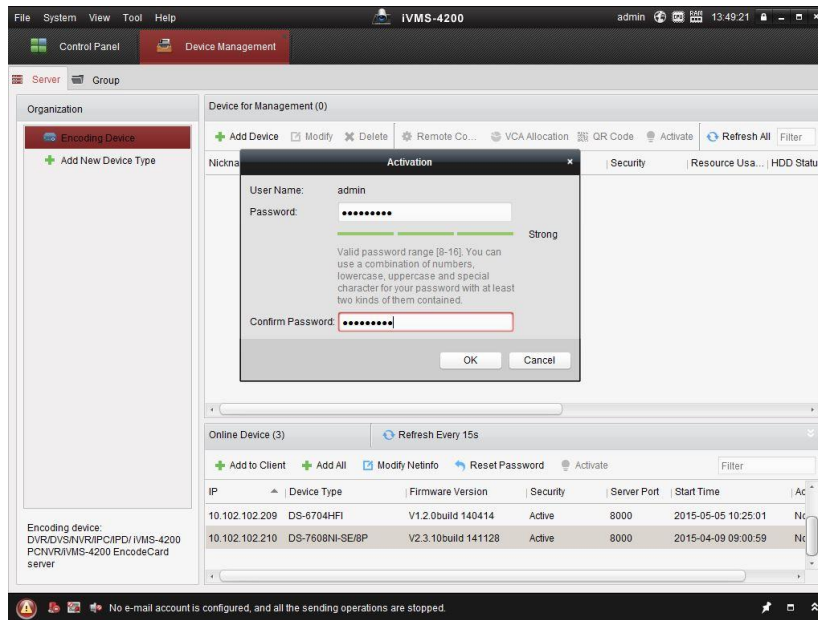

Figure 35 Strong (Adequate) Password Strength

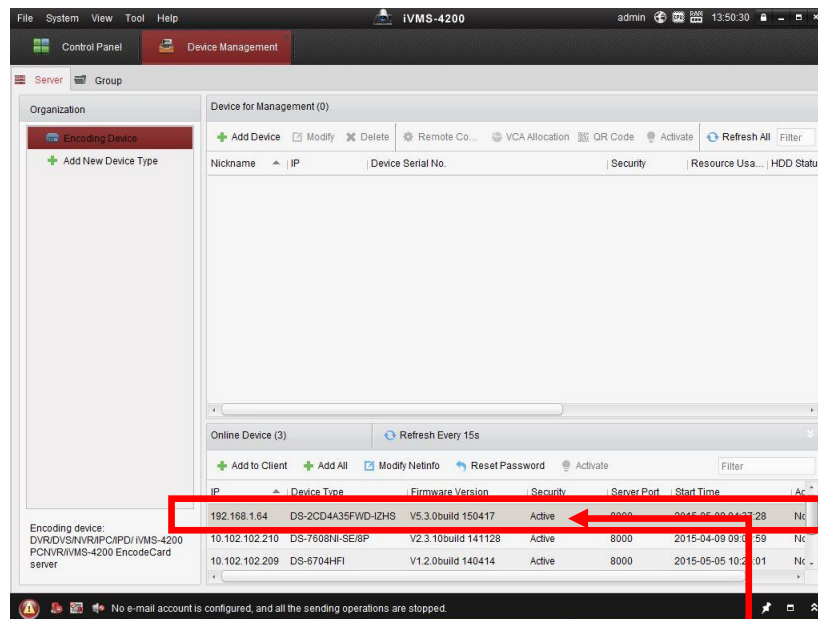

Figure 36 Active DVR/NVR Status

NVR Status:
Active

- **Web Interface Activation (use if the SADP or iVMS-4200 software do not support the activation procedure).**
 1. In a Web browser (i.e., Internet Explorer, Chrome, Safari), type the DVR's/NVR's IP address and press **Enter**.
 - The Activation Window will appear instead of the login page (**Figure 23**).
 2. Enter a new password into the "Password" field (see "Password Strength Levels" table on page 38 for guidelines).
 - The password strength will be displayed, accompanied by a color indicator:
 - Level 0—*Risky* (no indicator): Not acceptable
 - Level 1—*Weak* (pink indicator): Acceptable
 - Level 2—*Medium* (yellow indicator): Acceptable
 - Level 3—*Strong* (green indicator): Acceptable
 - Bar length indicates strength level (**Figure 24**).
 - Activation will be allowed if the password is of acceptable strength (**Figures 26, 27, 28**). A white checkmark will appear in a green circle to the right of the password field.
 - If the password is unacceptable strength ("Risky," **Figure 24**), a white X will appear in a red circle to the right of the password field and a warning dialog box will be displayed (**Figure 25**) explaining the requirements for an acceptable password.
 3. Press the **OK** button.
 - After a successful activation the user will be logged in to the DVR's/NVR's live view page.

Activation

User Name admin

Password

Valid password range [8-16]. You can use a combination of numbers, lowercase, uppercase and special character or your password with at least two kinds of them contained.

Confirm

OK

©Hikvision Digital Technology Co., Ltd. All Rights Reserved.

Figure 37 Activation Window

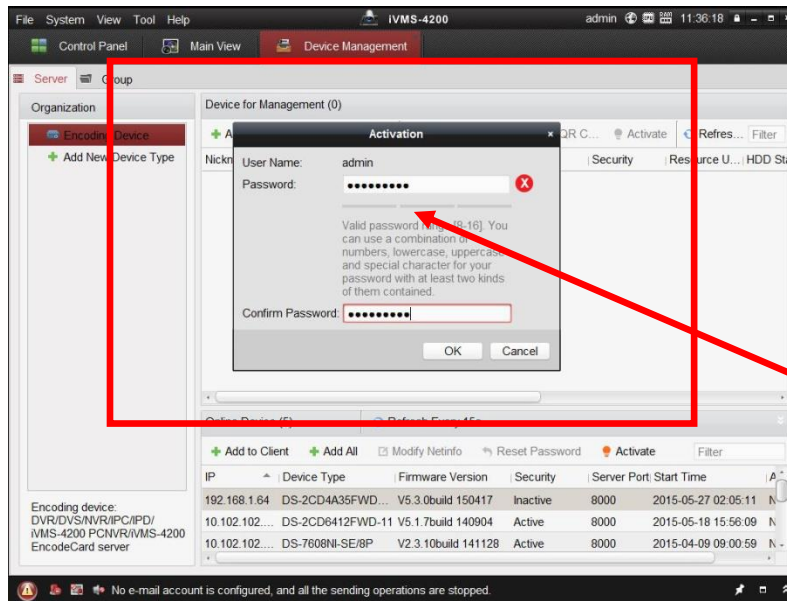

The "Strength Meter" does not light up

Figure 38 Risky (Inadequate) Password Strength

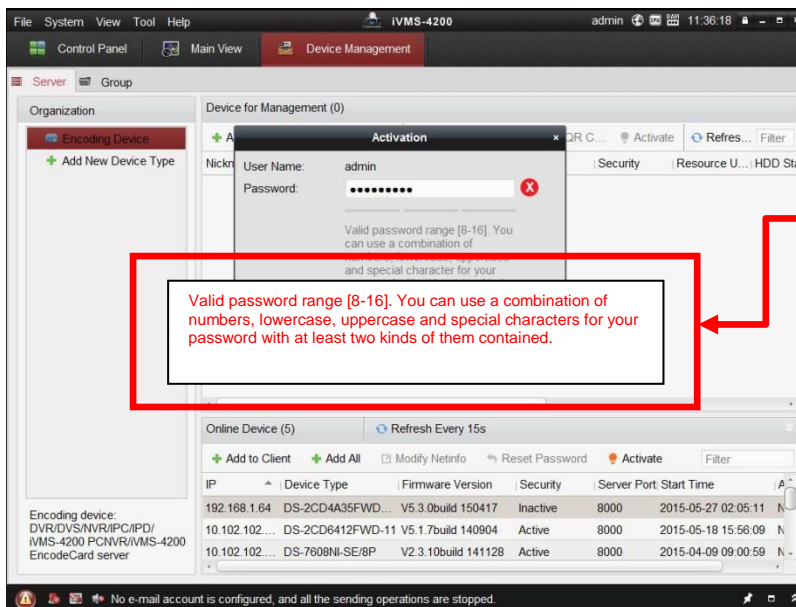

A message indicates that the password has to meet minimum requirements

Valid password range [8-16]. You can use a combination of numbers, lowercase, uppercase and special characters for your password with at least two kinds of them contained.

Figure 39 Risky (Inadequate) Password Warning Window

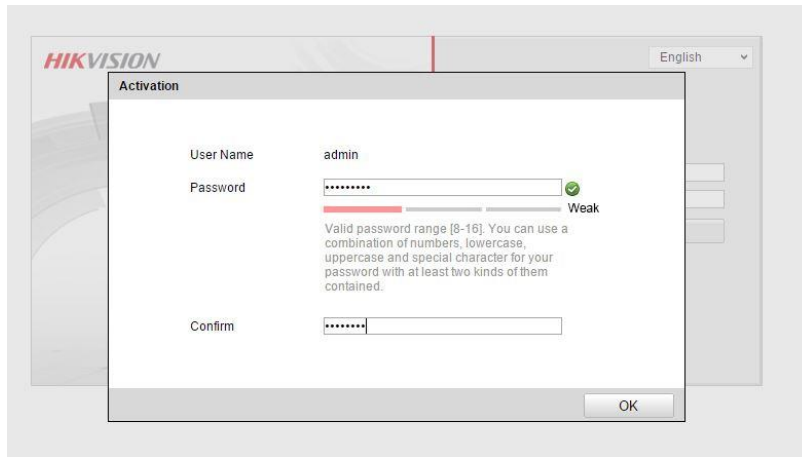

Figure 40 Weak (Acceptable) Strength Password

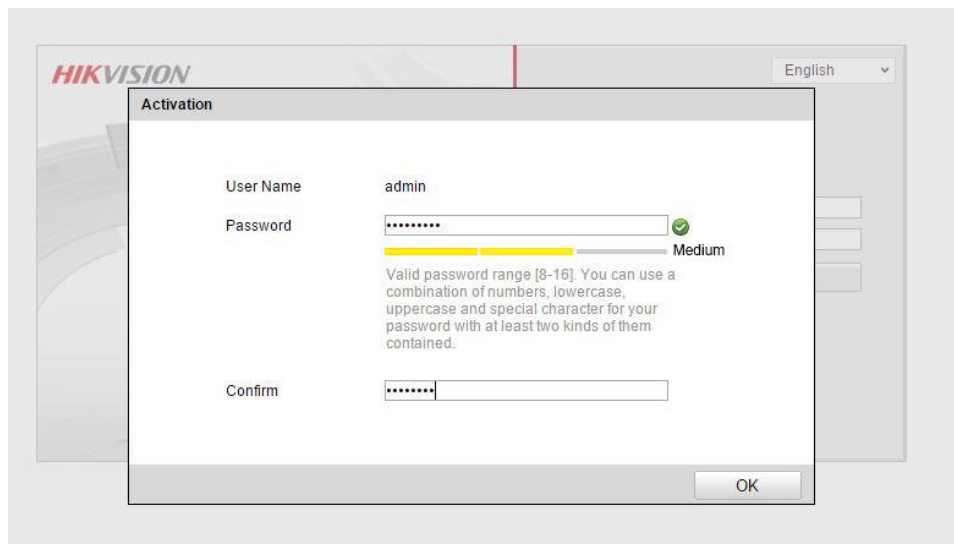

Figure 41 Medium (Acceptable) Strength Password

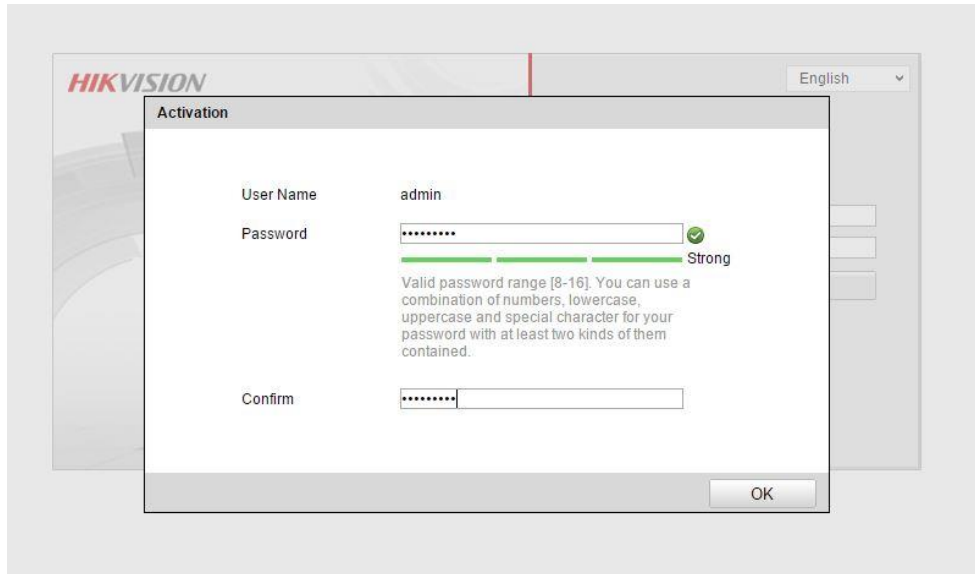

Figure 42 Strong (Acceptable) Strength Password

Password Strength Levels*

STRENGTH LEVEL	DESCRIPTION
<p style="text-align: center;">Level 0 (Risky)</p> <p>NVRs <u>will not</u> accept a Level 0 password</p>	<p>Password length is fewer than eight characters, contains only one type of character, is the same as the user name, and/or is the mirror writing of the user name. This type of password <u>will not</u> be accepted.</p>
<p style="text-align: center;">Level 1 (Weak)</p> <p>NVRs <u>will</u> accept a Level 1 password</p>	<p>Password contains two kinds of characters. The combination is number + lowercase letter or number + uppercase letter, and the password length is at least eight characters. This type of password <u>will</u> be accepted.</p>
<p style="text-align: center;">Level 2 (Medium/Fair)</p> <p>NVRs <u>will</u> accept a Level 2 password</p>	<p>Password contains two types of characters. The combination is neither number + lowercase letter <i>nor</i> number + uppercase letter, and the password length is at least eight characters. This type of password <u>will</u> be accepted.</p>
<p style="text-align: center;">Level 3 (Strong)</p> <p>NVRs <u>will</u> accept a Level 3 password</p>	<p>Password contains more than three types of characters, and the password length is at least eight characters. This type of password <u>will</u> be accepted.</p>

NOTE: Types of characters are lowercase letters, uppercase letters, numbers, and special characters. Only ASCII characters are allowed.

* **NOTE:** The strength level indicator colors can vary by activation process, model number, and device type.

CHAPTER 3

Getting Started

Starting and Shutting Down Your DVR

Proper startup and shutdown procedures are crucial to expanding the life of your DVR.

Startup Your DVR

- Ensure the power supply is plugged into an electrical outlet. It is HIGHLY recommended that an Uninterruptible Power Supply (UPS) be used in conjunction with the unit. The Power indicator LED on the front panel should turn red, indicating the unit is receiving power.
- Connect the DVR to a VGA monitor. You will only see the DVR menu system when it's connected to a VGA monitor.
- Press the POWER switch on the back rear panel. The Power indicator LED should turn blue. The unit will begin to start.
- After startup, the Power indicator LED will remain blue. A launch screen with the status of the HDD will be shown (**Figure 43**). If an 'X' is shown, it means that the HDD is not installed or cannot be detected.



Figure 43 Startup Splash Screen

Shutdown Your DVR

There are two proper ways to shut down your DVR. To shut down your DVR:

Option 1:

1. Press and hold the POWER button on the front panel for 3 seconds.
2. Enter the administrator's username and password in the dialog box for authentication.
3. There will pop-up an attention box.
4. Click the Yes button to shut down your DVR and click the No button to cancel.

Option 2:

1. Shutdown your DVR by going to Menu > Maintenance, click  in the lower left corner to pop-up the Shutdown menu, as shown in **Figure 44**.

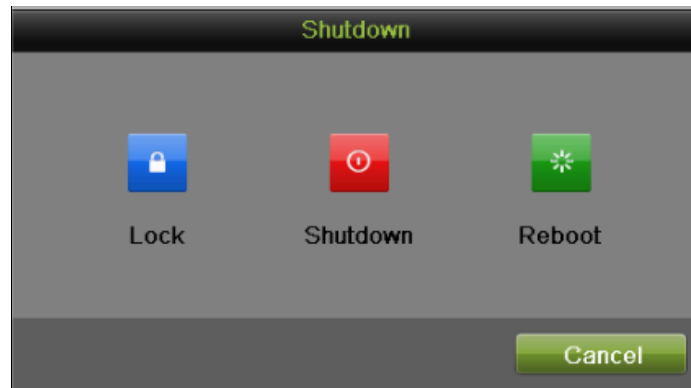

Figure 44 Shutdown Menu

2. Select the Shutdown button.
3. Click the Yes button.

Note:

Do not press the POWER button again when the system is shutting down.

Rebooting Your DVR

While in the Shutdown menu (**Figure 44**), you may also reboot your DVR by clicking Reboot.

Locking Your DVR

Locking your DVR will return you to the Live Feed mode, which will require the correct user name and password to exit out of it and do operation. You have two methods to lock your DVR.

- Enter the Shutdown menu by going to Menu > Maintenance > Shutdown, and click the Lock button.
- Click  on the lower left corner of Menu interface to lock your DVR.

Note:

You can also set auto lock time to lock the menu for a certain period of time inactivity. Enable auto locking by going to Menu > System Configuration > General > More Setting, and select auto lock time in the Auto Locktime dropdown list.

Setting Date and Time

It is extremely important to setup the system date and time to accurately timestamp recordings and events.

To setup date and time as following steps:

Steps:

1. Enter the System Configuration menu by going to Menu > System Configuration > General.
2. Select the Time/Date tab, as shown in **Figure 45**.





Figure 45 System Configuration Menu

3. The current system time and date as well as the time zone will be displayed. Using the directional buttons on the front panel/remote or the mouse, select the correct date, time and time zone.
4. To enable Daylight Savings Time, click and check the Enable DST checkbox and there will pop-up the DST Setting menu, as shown in **Figure 46**. You can check the Auto DST Adjusting checkbox or manually check the date of the DST period and click the Apply button to confirm the setting. Click the OK button to return to the up level menu.



Figure 46 DST Settings Menu

5. To acquire the time and date over an NTP (Network Time Protocol) Server, check the Enable NTP checkbox. You can set the interval and enter your own NTP server.
6. Click the Apply button to save the settings and click  to exit out of the menu.
Clicking  without clicking the Apply button will exit the menu without saving.

Checking the Status of Your DVR

The current status of your DVR can be checked at anytime by going to the System Information menu. The System Information menu, as shown in **Figure 47**, can be accessed by going to Menu > System Information.



Figure 47 System Information Menu

1. Select the Device Info tab to enter the Device Information menu to view the device name, model, serial No., firmware version and encode version, as shown in **Figure 48**.
2. Select the Camera tab to enter the Camera Information menu to view the status of each camera, as shown in **Figure 49**. You can click the refresh button to renew the information displayed.



Camera	Camera Name	Status	Motion Detection	Video Ta	Video Loss	Video Ex
A1	Camera 01	Enabled	Used	Not used	Not used	Used
A2	Camera 02	Enabled	Used	Not used	Not used	Used
A3	Camera 03	Enabled	Used	Not used	Not used	Used
A4	Camera 04	Enabled	Used	Not used	Not used	Used
A5	Camera 05	Enabled	Used	Not used	Not used	Used
A6	Camera 06	Enabled	Used	Not used	Not used	Used
A7	Camera 07	Enabled	Used	Not used	Not used	Used
A8	Camera 08	Enabled	Used	Not used	Not used	Used
A9	Camera 09	Enabled	Used	Not used	Not used	Used
A10	Camera 10	Enabled	Used	Not used	Not used	Used
A11	Camera 11	Enabled	Used	Not used	Not used	Used
A12	Camera 12	Enabled	Used	Not used	Not used	Used

Figure 48 Camera Information Menu

3. Select the Record tab to enter the Record Information menu to view the recording status and encoding parameters of each camera, as shown in **Figure 49**. You can click the refresh button to renew the information displayed.



Figure 49 Record Information Menu

- Select the Alarm tab to enter the Alarm Information menu to view the alarm information, as shown in **Figure 50**. You can click the refresh button to renew the information displayed.



Figure 50 Alarm Information Menu

5. Select the Network tab to enter the Network Information menu to view the network information, as shown in **Figure 51**. You can click the refresh button to renew the information displayed.



Figure 51 Network Information Menu

6. Select the HDD tab to enter the HDD Information menu to view the HDD status, free space, capacity, etc, as shown in **Figure 52**. You can click the refresh button to renew the information displayed.



Figure 52 HDD Information Menu

CHAPTER 4

Live Feed

Watching a Live Feed

The Live Feed mode is automatically started after the DVR boots up. It is also at the very top of the menu hierarchy, thus hitting the ESC button multiple times (depending on which menu you're on) will bring you to the Live Feed mode.

Understanding Live Feed Icons

There are multiple icons on each display in Live Feed mode to indicate different camera status and settings. These icons include:



Event Icon: Indicates video loss or tampering, motion detection and/or sensor alarm.



Record Icon: Indicates the current channel is recording. The recording may have been started from a schedule, and/or triggered from motion or alarm.



Manual Record Icon: Enable/disable manual record.



Instant Playback Icon: Instant playback the record in last five minutes.



Audio On/Audio Off Icon: Enable/disable audio for selected display.



Capture Icon: Capture images for the selected display.



PTZ Control Icon: Enable PTZ control mode for the selected display.



Digital Zoom Icon: Zoom in the selected area to the full screen.



Image Settings Icon: Enter the image setting menu for selected display.



Live View Strategy Icon: Set strategy for selected display, including Real-time, Balanced and Fluency.



Text Hide: Hide the POS information on screen display.



Close Icon: Exit out of current setting and return to previous mode.

Note:

Status for video loss is only valid with analog cameras. Event icons will only be displayed when armed, except for the video loss alarm.

Note:

Live View Strategy setting is only valid with IP cameras.

Operating the Live Feed

In Live Feed mode, you may adjust the settings for individual cameras by left-clicking on the desired display with the mouse. The selected display will be surrounded with a green border, as shown in **Figure 53**.



Figure 53 Live Feed Mode

The settings you may adjust with each display include:

Manual Record:

Enable/disable manual record by clicking the icon for a selected display.

Instant Playback:

Click the Instant playback icon to show the record in last five minutes. If no record is found, it means there is no record during the last five minutes

Audio:

Enable/disable audio for a selected display. To enable/disable audio:

1. Select one display to enable/disable audio.
2. Enable audio by clicking the Enable Audio icon and disable audio by clicking the Disable Audio icon. An error message similar to the one shown in **Figure 54** will pop-up if the Enable Audio option is not selected in the Live View menu for the specified channel.

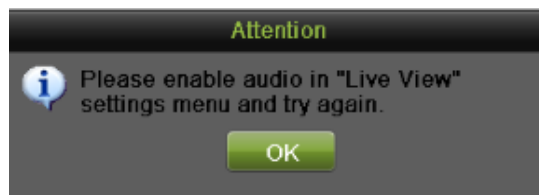

Figure 54 Enable Audio Attention Message

Capture:

Do capture by clicking the icon for a selected display.

PTZ Control:

If the selected camera is a PTZ camera, you may control it directly from the display. Control a PTZ camera as following steps:

Steps:

1. Select the display that corresponds to a PTZ camera.
2. Click the PTZ Control icon. This will bring up additional PTZ control buttons, as shown in **Figure 55**.



Figure 55 PTZ Control Mode

3. Control the PTZ by using PTZ control buttons. Pan and tilt PTZ by clicking on the directional buttons. Zoom in and out using the Zoom In/Out buttons and recall presets, patrols and patterns by clicking the corresponding icons. Below is the description of the PTZ control icons:



Direction buttons and the auto-cycle button



Zoom+/Zoom-



Focus+/Focus-



Iris+/Iris-



The speed of the PTZ movement



Light On/Off



Wiper On/Off



3D-Zoom



Image Centralization



Menu

4. Click the Close icon to return to the Live Feed mode.

Note:

PTZ parameters for the camera must be set correctly before the PTZ can be controlled.

Digital Zoom Mode:

Enable digital zoom on the selected channel. Once enabled, the regular feed will be shown in the lower right corner while the zoomed in view will be shown on the full screen. The zoomed in region may be changed by moving the red rectangle in the regular feed window, as shown in the **Figure 56**. Right click to back to the Live Feed mode.



Figure 56 Digital Zoom

Image Settings:

Set the image mode and image parameters like brightness, contrast, saturation, hue and so on for selected display. To adjust the image settings of a display as following steps:

Steps:

1. Select display.
2. Click the Image Settings icon. This will bring up the Image Settings menu, analog camera is shown in **Figure 57**, IP camera is shown in **Figure 58**.

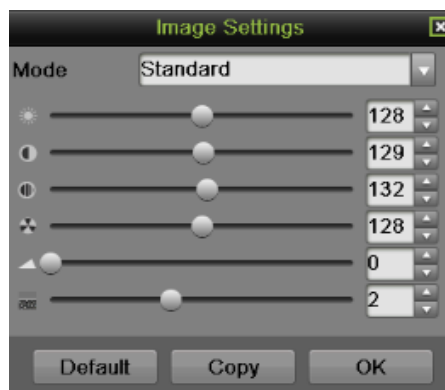

Figure 57 Analog Camera Image Settings Menu

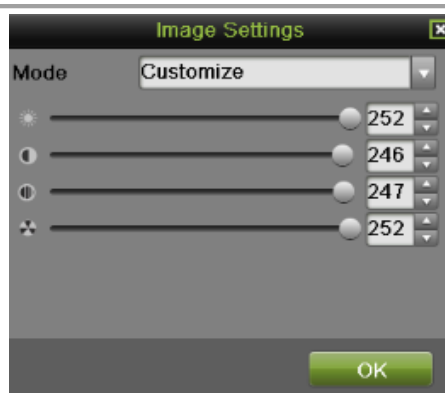







Figure 58 IP camera Image Settings Menu

3. For analog camera, there are four preset modes for selection: Standard, Indoor, Dim Light and Outdoor. You can select one according to the real situation.
4. You can also adjust the image parameters like Brightness , Contrast , Saturation , Hue , Sharpness  and Denoising  by dragging the corresponding icon. The affect will be displayed immediately on the screen.
 - Click Default will restore the default settings.
 - If the same settings can be applied in other channels, click the Copy button to pop-up a Copy to box and check the corresponding checkbox. Click the OK button to save and back to Image Setting menu. Click Cancel to exit without saving.
 - Click OK to save the settings and return to the Live Feed mode.
5. For IP camera, only Customize is supported. You can adjust the Brightness, Contrast, Saturation and Hue by dragging the corresponding icon. Click the OK button to save the settings and back to the Live Feed mode.

You can also enter the Image setting menu by going to Menu > Cameras Setup > Image, as shown in **Figure 59**. The steps are similar to the live feed icon setting steps. If the same settings can be applied in other channels, click the Copy button to copy it to other channels.



Figure 59 Image Settings Menu

Here we can set advanced image parameters like white balance, exposure, WDR, day/night switch, digital noise reduction, backlight compensation and video adjustment.

Live View Strategy:

Settings for live view strategy to adjust the picture settings of a display as follows:

1. Select display.
2. Click the Live View Strategy icon. This will bring up the Live View Strategy menu, as shown in **Figure 60**.

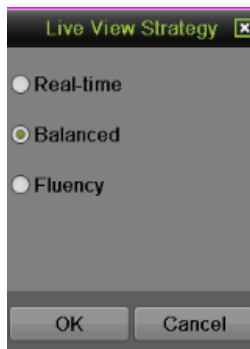

Figure 60 Live View Strategy Menu

3. There are three strategies for selection: Real-time, Balanced and Fluency.
4. Click OK to save the settings.

Display POS Data on the Live Video:

Settings for configuring how to display POS information on live feed.

1. Enter the POS configuration menu by going to Menu > System Configuration > POS.
2. To handle how to display POS data, click SET on the POS configuration interface.

- a. **Trigger Channel:** Click the check box to select the camera(s) which will start recording of both video and POS data during the transaction. Users can select one camera or multiple cameras to be triggered for each POS terminal.



Figure 61 Handle Settings

- b. **Handling:** Click the check boxes to select different ways to notify user that transactions begin.



Figure 62 Handle Settings

- c. **PTZ Linking:** Select the PTZ(s) which will start action (preset, patrol and pattern) during the transaction. Users can select one camera or multiple cameras to be triggered for each POS terminal.



Figure 63 PTZ Linking

-
- d. **Overlay Zone:** Use mouse to choose where on the screen should POS information be displayed. The zone within the yellow rectangle is the overlay zone.



Figure 64 Overlay Zone

Using Display Menu

The Display Menu can be accessed by right-clicking the mouse on any of the display in Live Feed mode. The Display Menu, as shown in **Figure 65**, allows you to quickly change into different display modes and to start/stop auto-switching of the display modes.

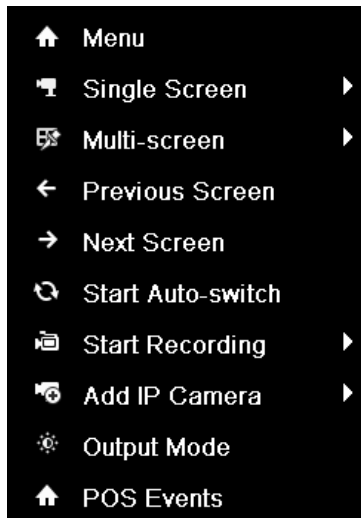
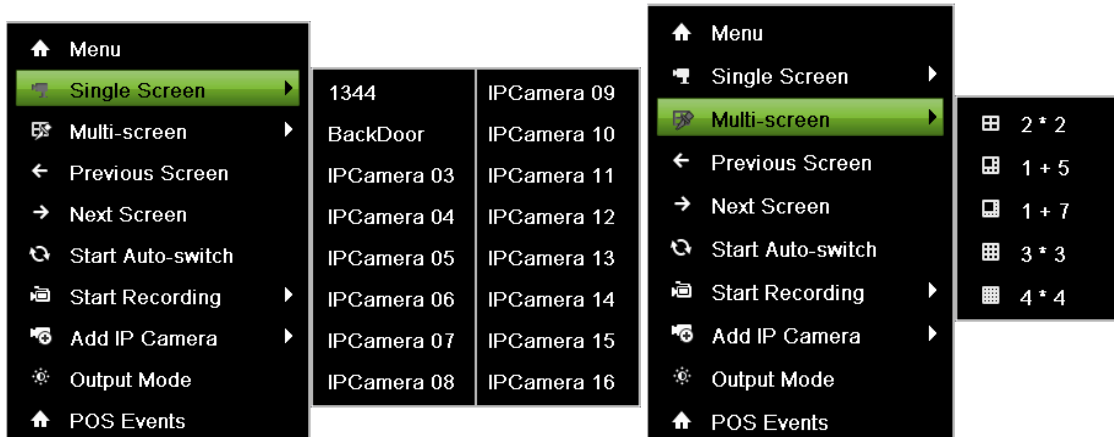

Figure 65 Live Feed Display Menu



Menu: Click to go to DVR Main Menu. If the system is locked, you must enter the current Admin password to exit out of the Live Feed.



Single Screen/Multi-Screen: Click to switch the display mode.

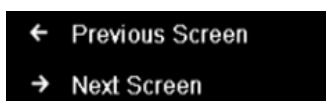

Previous Screen/Next Screen: Click to view the previous/next set of display. In a 2x2 mode, this will show the next four display. In a 3x3 mode, this will show the next nine display.



Start/Stop Auto-Switch: Click to start/ stop auto-switch. Auto-switch will cycle through selected cameras. Switching of camera can be based on an individual or multiple cameras.

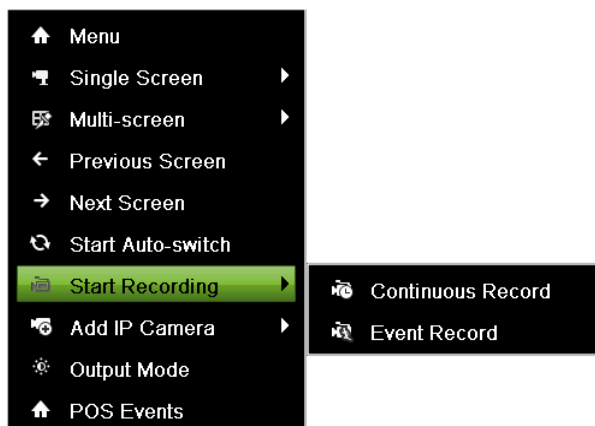

Start Recording: Click the Continues Record/Event Record item. This will bring up an attention box shown below. If you click yes, it will start all-day continues/event recording of all channels.

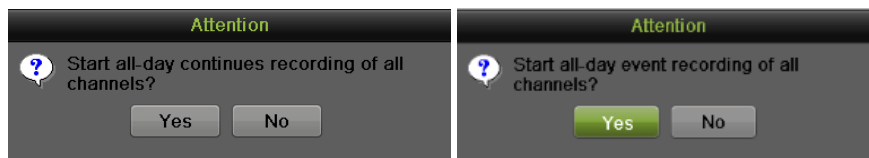

Output Mode: Click the Output Mode item. This will bring up an Output Mode menu shown below. Four modes are available: Standard, Bright, Gentle and Vivid. Select one and click the Apply button to save the setting.

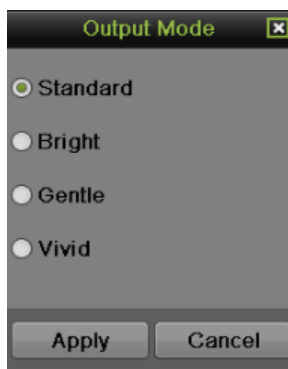

POS events: Click the POS events item. This will bring up a list of all POS events on this day.

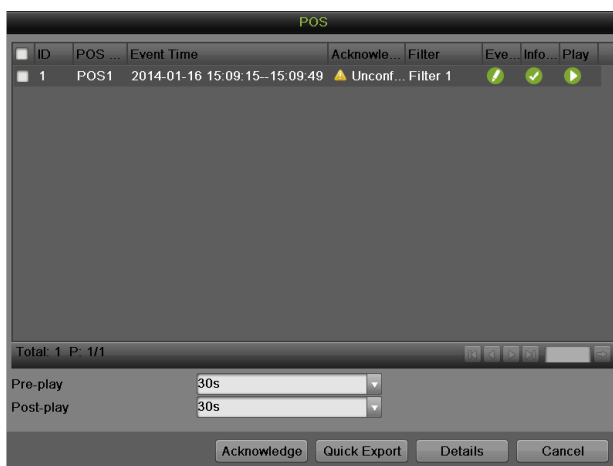

Before you start Auto-switch, you should set Dwell Time in Live View setting menu by going to Menu > System Configuration > Live View > General.

Note:

After 20 seconds of inactivity, the DVR will automatically exit out of the Display menu and go back into the Live Feed mode.

Note:

The auto lock menu setting is selected by default, meaning the Admin password must be entered to exit out of the Live Feed into the Main Menu.

Configuring Live Feed Displays

Live Feed displays can be customized to your own needs.

To customize display settings:

1. Set language, CVBS output standard, resolution and so on by going to Menu > System Configuration > General > Display, as shown in **Figure 66**.

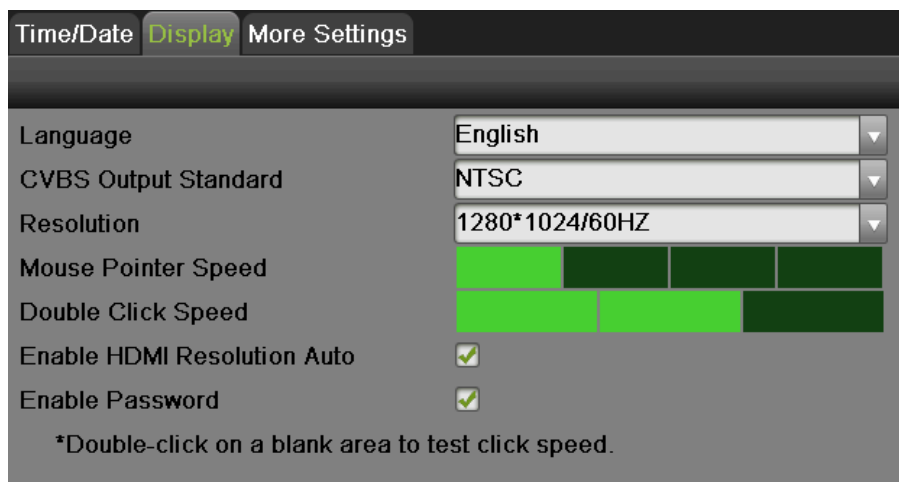

Figure 66 Display Menu

The settings available to configure in this menu include:

- **Language:** The default language used is English.
 - **CVBS Output Standard:** Select the output standard to NTSC or PAL, which must be the same with the video input standard.
 - **Resolution:** Select the appropriate resolution.
 - **Mouse Pointer Speed:** Set the speed of mouse pointer and 4 levels are configurable.
 - **Double Click Speed:** Set the double click speed of mouse.
 - **Enable HDMI Resolution Auto:** Automatically adjust the resolution of HDMI output based on display.
 - **Enable Password:** Require password when access menu in preview mode.
2. Set device name, device no., CVBS output brightness, auto lock time, menu output mode and VGA/HDMI synchronous output by going to Menu > System Configuration > General > More Settings, as shown in Figure 67.

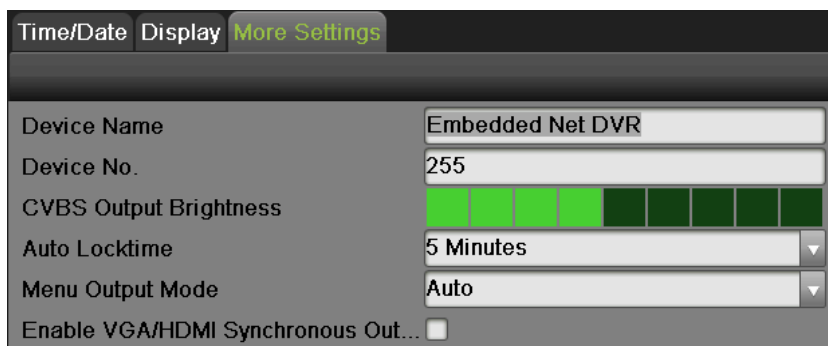

Figure 67 More Settings Menu

The settings available to configure in this menu include:

- **Device Name:** Edit the name of the device.

- **Device No.:** Edit the number of the device.
 - **CVBS Output Brightness:** Adjust the video output brightness.
 - **Auto Locktime:** Set the auto lock time of menu.
 - **Menu Output Mode:** Select the menu output mode from Auto, HDMI, VGA and Main CVBS.
 - **VGA/HDMI Synchronous Output:** Select whether output VGA and HDMI signal simultaneously or not.
3. Set the live view interface parameters and event output by going to Menu > System Configuration > Live View > General, as shown in **Figure 67**.



Figure 68 Live View Menu

The settings available to configure for each video output include:

- **Video Output Interface:** Designates the output including Main CVBS, HDMI, VGA, and Spot Output1, Spot Output2, Spot Output3 and Spot Output4.
- **Live View Mode:** Designates the display mode for Live Preview.
- **Dwell Time:** Set the time to dwell between switching of channels when Start Auto-switch is selected in Live Preview.
- **Enable Audio Output:** Enable or disable audio output for the selected video output.
- **Event Output:** Designates the output to show event video.
- **Full Screen Monitoring Dwell Time:** Set the time to dwell between switching of channels when events occur.

Setting Camera Order

Setting the camera order allows you to logically position cameras for more efficient monitoring of your own individual location.

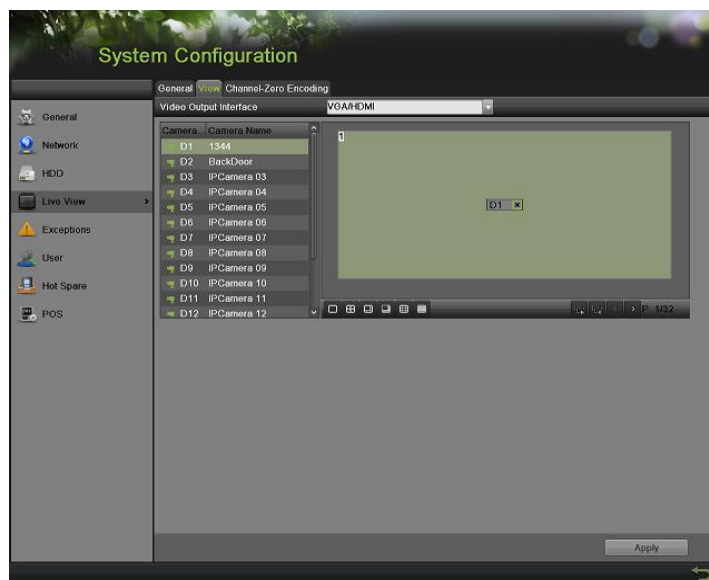







Figure 69 Camera Order Settings Menu

To set the camera order:

1. Enter the Live View menu, shown in **Figure 68** by going to Menu > System Configuration > Live View.
2. Select the View tab.
3. Select the Video Output Interface to configure camera order for.
4. Select the Screen Configuration you would like to use in Live Feed by clicking . The preview of the screen configuration on the right will change depending on the option selected.
5. Click to select a screen in the right region and double-click to select a channel in the left region. Thus the selected channel will be displayed in the corresponding screen.

Note:

 means no channel will be displayed in this screen.

6. Click  to start live view of all channels and click  to stop live view all channels.
Click  or  to go to the previous or next page. For example, in 2x2 screen configuration mode, pressing the Next button will bring up the next set of 4 displays.
7. Click the Apply button to save settings.
8. Click  to exit out of the menu.

Channel-Zero Encoding

Channel-Zero Encoding can be chosen to decrease the bandwidth requirement without affecting the image quality when you need to get a remote view of many channels in real time from web browser or remote client. To setup channel-zero encoding as following steps:

Steps:

1. Enter the Live View menu by going to Menu > System Configuration > Live View
2. Select the Channel-Zero Encoding tab, as shown in **Figure 70**.

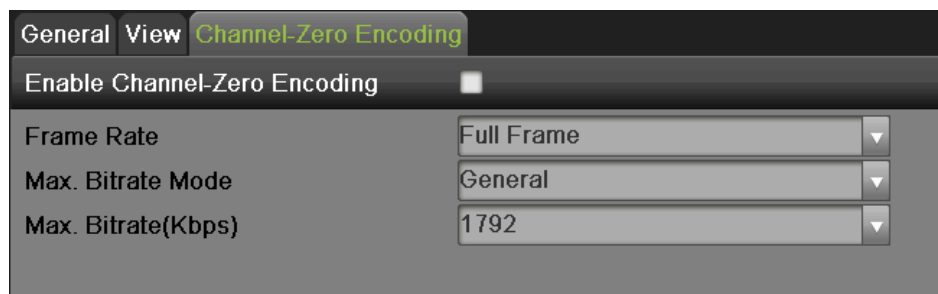

Figure 70 Channel-Zero Encoding Menu

3. Check the checkbox to enable channel-zero encoding.
4. Set the Frame Rate, Max. Bitrate Mode and Max. Bitrate.

After you set the channel-zero encoding, you can get a view in the remote client or IE browser of all the channels in one screen.

Event Hint

Event hint allows display the event information in the live view interface when there is an event. To setup event hint as following steps:

Steps:

1. Enter the Exceptions menu by going to Menu > System Configuration > Exceptions
2. Check the checkbox to enable event hint, as shown in **Figure 71**.



Figure 71 Event Hint Setting Menu

3. Select the Event Type Settings to configure. The event types include:

HDD Full: If selected, display event information when HDD is full.

HDD Error: If selected, display event information when errors on the HDD are detected.

Network Disconnected: If selected, display event information when a network disconnected is detected.

IP Conflicted: If selected, display event information if an IP conflicted is detected.

Illegal Login: If selected, display event information when illegal logins are detected.

Video Exception: if selected, display event information when video signal is abnormal.

Input/Output Video Standard Mismatch: If selected, display event information when video output standard does not match.

Recording/Capture exception: If selected, display event information when recording/capture exception is detected.

Video Signal Loss: If selected, display event information when video signal losses.

Alarm Input Triggered: If selected, display event information when alarm input is triggered.

Video Tamper Detected: If selected, display event information when detects video tampering.

Motion Detection: If selected, display event information when detects motion in video.

IP Camera Conflicted: If selected, display event information when IP cameras conflict with others.

Device Temperature Exception: If selected, display event information when device temperature is abnormal.

Hot Spare Exception: If selected, display event information when hot spare function is abnormal.

VCA Exception: If selected, display event information when VCA event is triggered..

All: if selected, trigger action when any one of events above is detected.

4. Select the Apply button to save the exception settings and select  to return to the previous

menu. Selecting  without clicking Apply will quit out of the menu without saving settings.

Select the Apply button to save the exception settings and select  to return to the previous

menu. Selecting  without clicking Apply will quit out of the menu without saving settings.

CHAPTER 5

Record Settings

Configuring Settings for Recording

There are multiple ways to setup your DVR for recording. They include setting up a recording schedule, triggering a recording by motion detection, POS, VCA and/or a sensor alarm

Configuring Recording Settings

Before setting your DVR up for recording, certain settings should be configured first.

The first set of settings to configure in this menu is the recording quality settings. To configure the recording quality settings as following steps:

1. Enter the Recording Quality Settings menu by going to Menu > Recording Configuration > Recording Quality as shown in **Figure 72**.



Figure 72 Recording Quality Settings Menu

2. Select main stream tab to configure the parameters of main stream.
 - 1) Select the camera to configure in the Camera dropdown list.
 - 2) Select the Recording Mode to configure. Both Continuous and Event can be configured..
 - 3) Select the stream type in the Stream Type dropdown list. The options include Video & Audio and Video.

- 4) Select the camera resolution in the Resolution dropdown list.
 - 5) Select the bit rate type in the Bitrate Type dropdown list. The options for the camera bit rate type include Variable and Constant
 - 6) Select the recording Frame Rate to use for the designated camera. A rate of 30 (Full Frame) all the way down to 1/16 of a frame can be selected.
 - 7) Set the video quality using the Video Quality slider. Increasing the video quality will also increase the max. bit rate recommended. The max. bit rate can be adjusted according to this recommend.
 - 8) Select the max. bit rate mode in the Max. Bitrate Mode dropdown menu. The options for the camera max. bit rate mode include General and Customize (32-8192kbps).
 - 9) Check the checkbox of record audio to enable or disable audio while recording.
 - 10) Select the Video Stream to choose different kind of stream as recording stream. The options for the video stream include main stream and substream.
 - 11) Click the Apply button to save the settings.
 - 12) Click the Copy button to copy the settings to other channels if the same settings can also be used for other channels.
3. Select Substream tab, as shown in **Figure 73**, to configure the parameters of sub stream. The steps are the same as main stream configuration.

Main Stream	Substream	Record	Capture
Camera	Analog 1		
Stream Type	Video & Audio		
Resolution	176*120(QCIF)		
Bitrate Type	Variable		
Video Quality	<input type="checkbox"/> <input type="checkbox"/> <input type="checkbox"/> <input type="checkbox"/> <input type="checkbox"/>		
Frame Rate	Full Frame		
Max. Bitrate Mode	General		
Max. Bitrate(Kbps)	128		
Max. Bitrate Recommended	256(Kbps)		

Figure 73 Substream Settings Menu

4. Select Record tab, as shown in **Figure 74**, to configure some parameters of recording.

Main Stream	Substream	Record	Capture
Camera	Analog 1		
Pre-record	5s		
Post-record	5s		
Erase Video After (days)	0		
Enable CABAC	<input type="checkbox"/>		

Figure 74 Record Settings Menu

- 1) Select the Pre-record time. The pre-record time is the time in seconds to record before a recording is triggered. Setting the pre-record time to MAX will allow the DVR to use up to the maximum available buffer space for recording.

- 2) Select the Post-record time. The post-record time is the time in seconds to also record after a recording has ended.
- 3) Enter the Erase Video After. The Erase Video After time denotes the amount of days that files will be deleted after its initial recording. Setting the time to 0 will allow the DVR to only delete and overwrite files when the HDD is full.
- 4) If check the Enable CABAC checkbox, DVR will reduce the bit rate to improve the quality of image. This feature is supported by analog cameras only.

Note:

You must click the Apply button after adjusting the configuration of each tab before you move on to adjust another one.

Note:

Event recordings are recordings that are triggered from motion detection and/ or from an external alarm (See Configuring Alarms and Exceptions on Page 85).

Note:

If an event occurs during Continuous recording, the frame rate will automatically switch to that set for Event recording.

Note:

For holiday settings, you can refer to Page 55.

Configuring Record Schedule

A record schedule allows you to schedule multiple time periods per day for recording. Setting up a record schedule will allow you to further conserve disk space by recording only during the time periods you would like to record at.

Note:

In this chapter, we take the record schedule procedure as an example, and the same procedure can be applied to configure capture schedule. To setting the capture schedule, choose the Capture tab in the Schedule interface.

To setup a record schedule:

1. Enter the Schedule menu, shown in **Figure 75** by going to Menu > Recording Configuration > Schedule.
2. Select the Record tab to configure record schedule.



Figure 75 Record Schedule Configuration Menu

3. Select the camera to configure from the camera dropdown list.
4. Check the Enable Schedule checkbox to enable the record schedule. If the checkbox is unchecked, the record schedule will be disabled.
5. Edit the record schedule. There are three ways to set the record schedule:
 - **Instant edit**
 - 1) On the Record menu, select a day from Monday to Sunday to configure schedule for.
 - 2) Setup time periods for schedule. If the 24HR checkbox is checked, recording will occur over the entire day. To setup multiple time periods, uncheck 24HR and enter the Start/End Time for the selected day. The start/End time are listed using a 24 hr cycle (i.e. 18:00 is equivalent to 6:00 pm). Up to 8 discontinuous periods can be configured for each day.
 - 3) Select recording type under Type for selected day of the week. Recording type includes Continuous for continuous recording or Event for recording when an event is triggered (i.e. from detected motion) for the selected time period.
 - 4) Select the Add button to add time frame to schedule. The newly added time frame will appear in the schedule on the right. You can click  to delete the selected time period on the right. Continuous recordings are shown in blue on the schedule while event recordings are shown in yellow. An example of this can be seen in **Figure 76**.

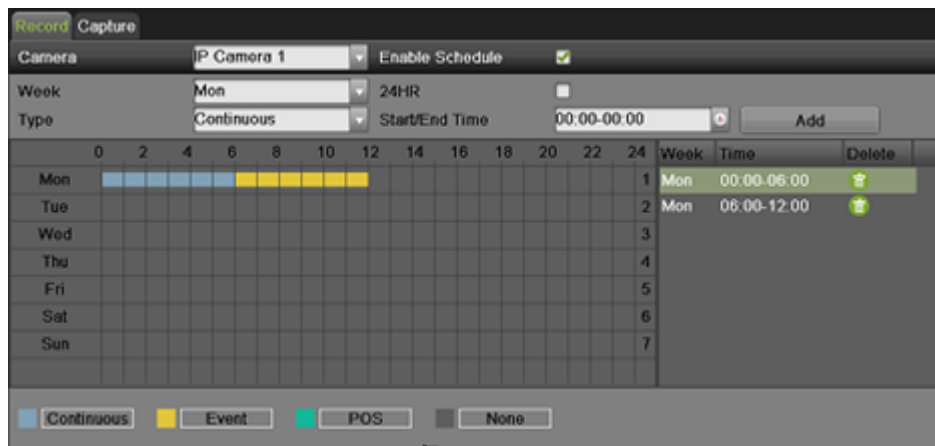

Figure 76 Record Schedule Configuration Example

- 5) If there are scheduling errors detected, error messages such as those shown in **Figure 77** will appear.

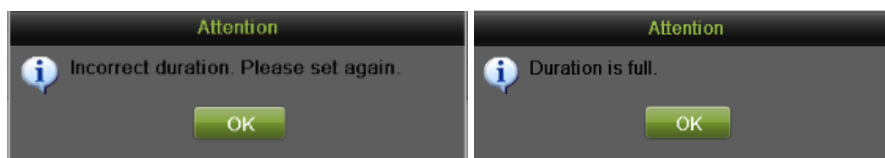

Figure 77 Schedule Configuration Error Messages

- 6) Repeat the above steps to set recoding schedule for other days in the week.
- **Edit the schedule**
- 1) Click the Edit button on the bottom right to pop-up the Edit Schedule menu, as shown in **Figure 78**.

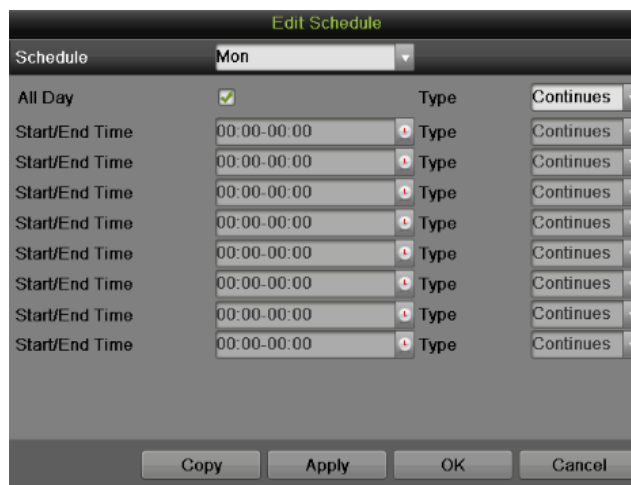

Figure 78 Edit Schedule Menu

- 2) Select a day from Monday to Sunday.

- 3) Setup time periods for schedule. If the All Day checkbox is checked, recording will occur over the entire day. To setup multiple time periods, uncheck All Day and enter the Start/ End Time for the selected day. You can select recording type for each period.
- 4) Click the Apply button to save the settings.
- 5) Repeat the above steps to set record schedule for other days in this week. If the schedule can also be applied to other days, click the Copy button to pop-up a Copy to box, as shown in **Figure 79**.

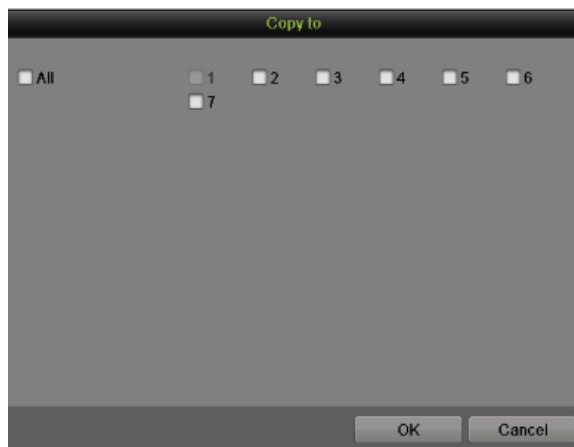



Figure 79 Copy to

- 6) Check the corresponding checkbox of the day to copy the record schedule to.
- 7) Click the OK button to save the settings and back to upper level menu or click the Cancel button to back without saving.
- 8) Click the Apply button to save the settings and click OK to exit.

- **Draw the schedule**

- 1) Click  to select a recording type. None means no recording.
 - 2) Use the mouse to drag and draw time periods in the assigned area. Up to 8 discontinuous periods can be configured for each day.
 - 3) Repeat the above steps to set record schedule for other days in the week.
 - 4) Click the Apply button to save the settings or click  to exit without saving.
6. Repeat the above steps to set record schedule for other channels. If the same schedule can be applied to other channels, click the Copy button to pop-up a Copy to box, as shown in **Figure 80**.

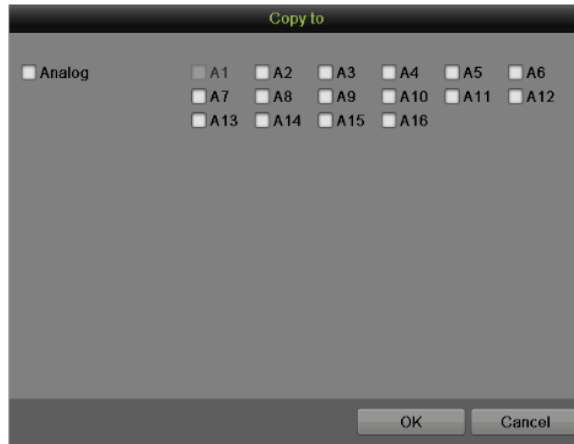

Figure 80 Copy to

-
7. Check the corresponding checkbox of other channels to copy the record schedule to.
 8. Click the OK button to save the setting and back to upper level menu or click the Cancel button to back without saving.
 9. Click the Apply button to save the settings.

Note:

Enable the Start Recording in the Display Menu will also create a schedule in Schedule Configuration. It will start all-day continue or event recording for all channels.

Configuring Holiday Settings

Follow the steps to configure the holiday settings.

Steps:

1. Enter the Holiday menu, shown in **Figure 81** by going to Menu > Recording Configuration > Holiday.



Figure 81 Holiday Settings Menu

2. Choose a holiday on the List show on the right. Click  to pop up an Edit menu, as shown in **Figure 82**.

The screenshot shows the 'Edit' dialog box for a holiday. It contains the following fields and controls:

- Holiday Name:** Text input field containing 'Holiday1'.
- Enable:** A checkbox that is currently unchecked.
- Mode:** A dropdown menu set to 'By Month'.
- Start Date:** A date picker showing 'Jan' and '1'.
- End Date:** A date picker showing 'Jan' and '1'.
- Buttons:** 'Apply', 'OK', and 'Cancel' buttons at the bottom.

Figure 82 Edit Menu

3. Edit the Holiday Name or use the default one.
4. Check the Enable checkbox.
5. Select Mode in the dropdown list. There are three different modes for the date format to configure holiday schedule.
6. Set the start and end date.

- Click the Apply button and OK to save settings and exit.

Configuring Settings for Capturing

Configuring Capture Quality Settings

Follow the introductions to configure capture quality settings.

Steps:

- Enter the Capture interface, shown in **Figure 83** by going to Menu > Recording Configuration > Recording Quality > Capture.



Figure 83 Capture Quality Settings Menu

- Select the camera to configure from the camera dropdown list.
- Select the Parameter Type to configure. Both Continuous and Event can be configured.
- Select the picture resolution in the Resolution dropdown list. The options for the capture resolution include AUTO, 4CIF, CIF and QCIF.
- Select the picture quality to High, Medium or Low in the dropdown list.
- Select the time period in second between two capturing actions.
- If the parameters can be used to other channels, click Copy to copy the settings to other channels.
- Click the Apply to save the settings.

Note:

The interval is the time period between two capturing actions. You can configure the parameters from 1s to 24 Hour.

Configuring Capture Schedule

Set the capture schedule, then the camera will automatically start/stop capturing according to the schedule. To setup a record schedule:

Steps:

- Enter the Schedule menu by going to Menu > Recording Configuration > Schedule.
- Select the Capture tab, as shown in **Figure 84**, to configure capture schedule.

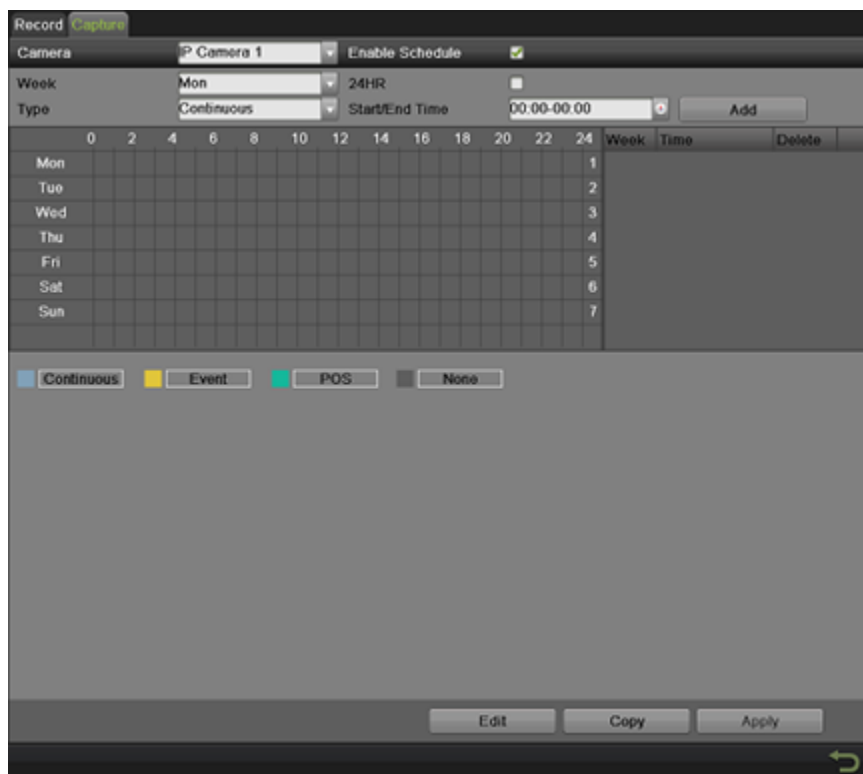

Figure 84 Capture Schedule Configuration Menu

3. Select the camera to configure from the camera dropdown list.
4. Check the Enable Schedule checkbox to enable the capture schedule. If the checkbox is unchecked, the capture schedule will be disabled.
5. Edit the capture schedule. The setting steps are the same with the record schedule settings.
6. Click the Apply button to save the settings.

CHAPTER 6

Playback

Playing Back a Recording

Previously recorded files can be played back using the Playback Interface. You must first search for recordings to play them back.

Understanding the Playback Interface

It's important to understand how to use the Playback Interface to efficiently navigate through recorded files. To access the Playback Interface, shown in **Figure 85**, go to Menu > Playback > Record.

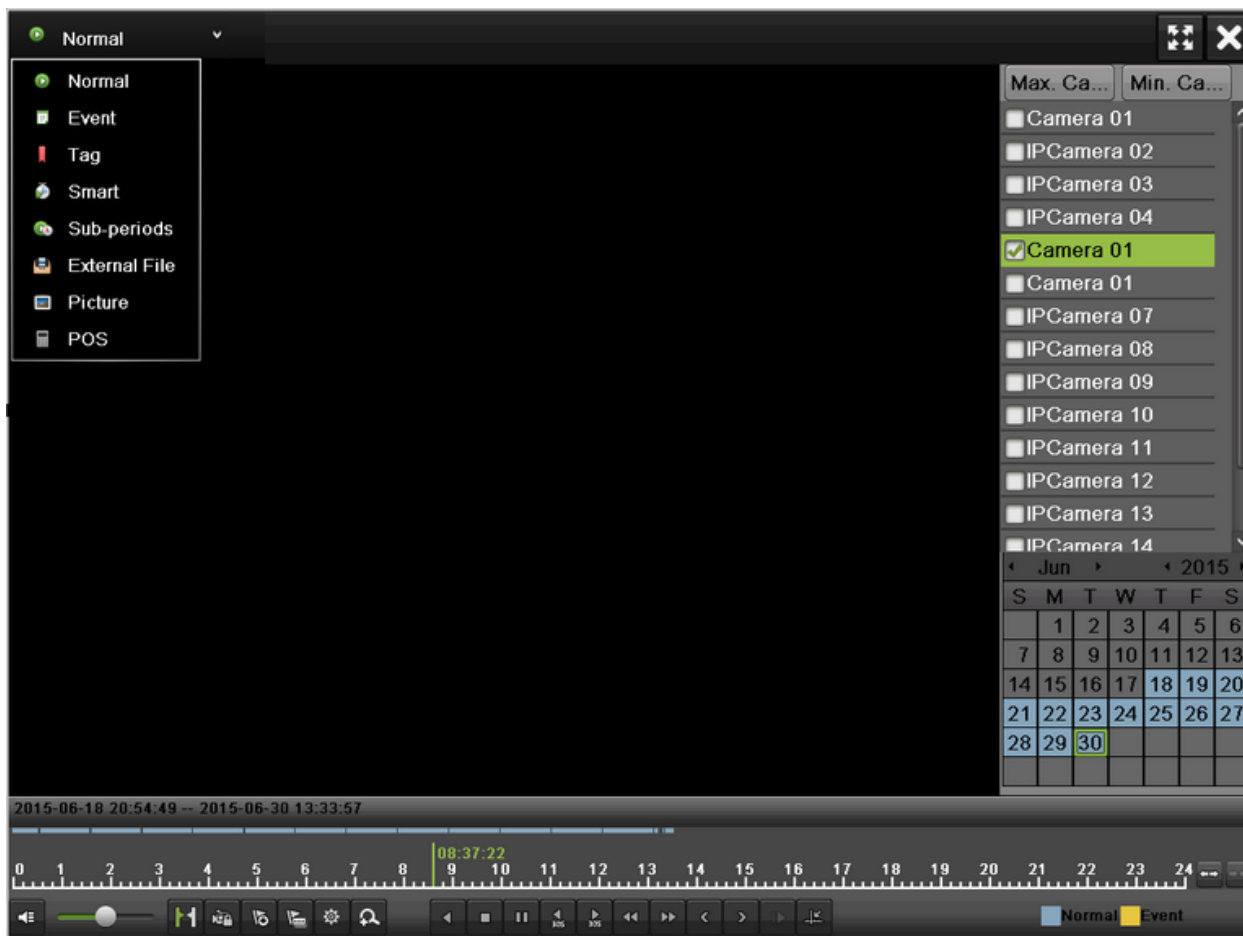

Figure 85 Playback Interface

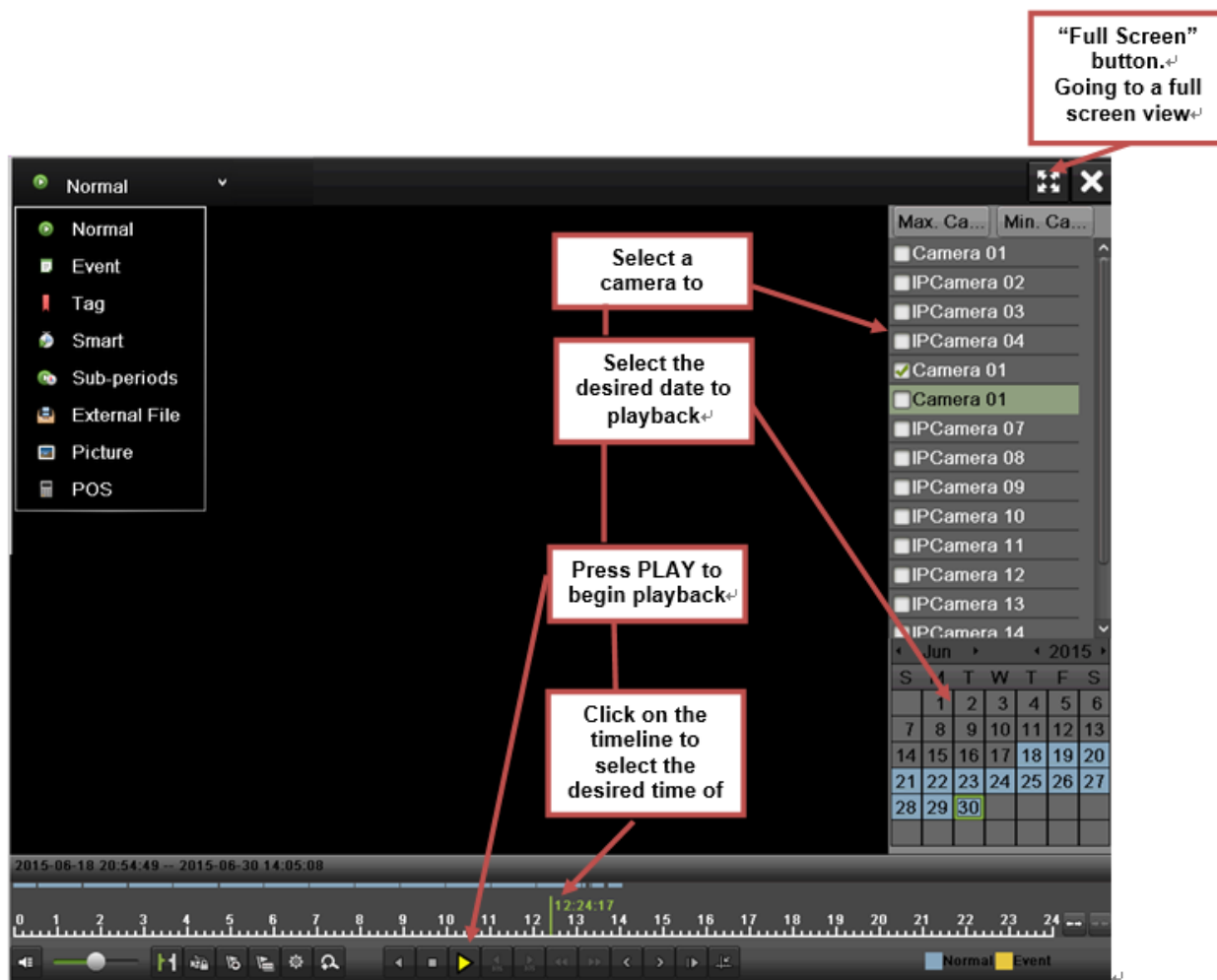

Figure 86 Playback Menu

Figure 58 shows some of the main features of the Playback Interface, which include:

Searching for Recorded Files

The Playback Interface allows for easy searching of recorded files. To search for recorded files using the Playback Interface:









1. Enter the Playback menu, shown in **Figure 86** by going to Menu > Playback > Record.
2. Select the channel to search for recordings on.
3. Select the date to search for recordings on using the calendar. The system date is shown on the left of the calendar. You may change the month and year of the calendar by clicking the left and right arrows next to the month and year. Dates with recordings in the selected month and channel are displayed in light blue. Dates without recordings are light gray. The active selected date is lighted up with a green box.
4. Click on the desired date that is highlighted in light blue to search for recordings. If recordings exist, the timeline will be filled with blue bars to designate recorded files. The playback marker, indicated by a green vertical line will automatically jump to the beginning of the earliest recordings for the selected date. The marker can be moved to any other location by clicking on the desired position on the blue bars or drag it.

5. Select  in the Playback Controls to start playback of the recording.

Playing Back Recorded Files

After finding the recordings you would like to play back, you may use the Playback Controls to navigate through the recording.

The controls found under Playback Controls include:

-  **Play Forward Button:** Button to playback recording.
-  **Play Reverse Button:** Button to playback recording in reverse.
-  **Speed Down Button:** Button to decrease play speed.
-  **Speed Up Button:** Button to increase play speed.
-  **Mute Button:** Button to enable and disable audio in playback mode.
-  **Add Default Tag:** Button to add default tag.
-  **Add Customized Tag:** Button to add customized tag and input tag name.
-  **Edit Tag:** Button to check, edit and delete tag(s).
-  **Enter/Exit Full Screen Mode:** Button to enter into and out of full screen mode.

To playback recorded files:





1. Search and select recording to play back in the Playback Interface.
2. Click the Play Forward button to begin playback of selected recording and the Pause button to pause playback.
3. You may slow down or speed up the playback speed by clicking the Speed Down/Speed Up button.
4. You can click  to zoom in/zoom out the timeline and select the exactly time.
5. Click the Full-Screen button to enter full-screen playback mode, shown in **Figure 87**.



Figure 87 Full-Screen Playback Mode

6. Clicking  will return to the original playback mode.
7. Click the Mute button to turn on and off audio during playback.
8. Click  to enable digital zoom. Once enabled, the regular recorded feed will be shown in the lower right corner while the zoomed in view will be shown on the full screen. The zoomed in region may be changed by moving the red rectangle in the regular recorded feed window.
9. Click  to add tag and manage it.
10. Click  to control playback.

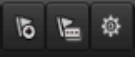
Playing Back Multiple Channels

You may also playback recordings from multiple channels simultaneously. To playback recordings from multiple channels:

1. Search and select recording to playback in the Playback Interface.
2. Enter into Full Screen mode, shown in **Figure 88** by clicking the Full Screen button.
3. In Full-Screen mode, you may select additional channels to playback by clicking the checkbox next to the desired camera in the Channel Selector panel. Playback will begin simultaneously on the selected channels.
4. You may stop playback on any of the channels by un-checking the checkbox next to the channel.
5. You can also select recording in Full Screen mode by double click the date on the calendar.

Note:

Up to 16 channels can be played back at the same time.

Smart Playback

Search and view events records in HDD more efficiently. Playback will be fast in non-event period, and will be normal speed during event period.

To do Smart Playback:

1. Enter the Smart interface, shown in Figure 88 by going to Menu > Playback > Smart.

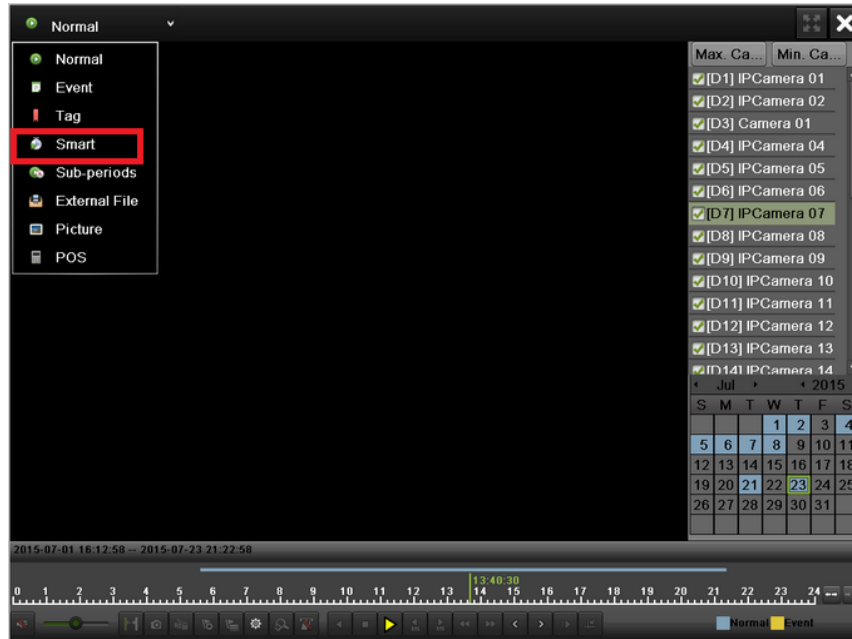

Figure 88 Smart Playback Interface

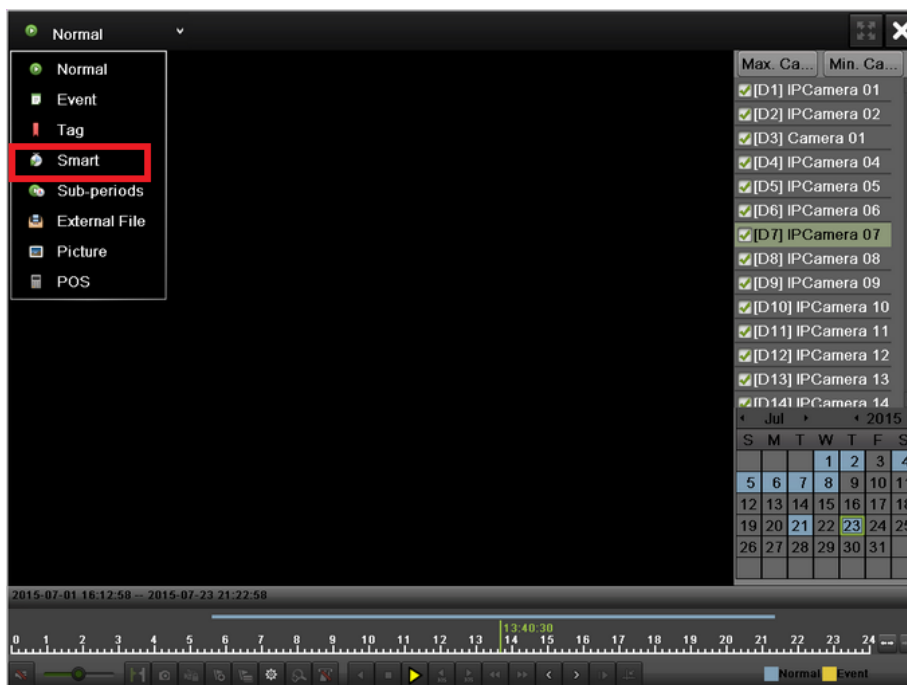

Figure 89 Smart Playback Menu







Smart search

In order to locate motion detection event easily and accurately in the playback progress line, the users are allowed to analyze a certain area (scene) dynamically, and to get all of the related motion detection events that occurred in this area.

Note:

The smart search function is only available for analog channels.

To use this function:

1. Enter the playback interface and play the video.
2. Move your mouse into the video window and drag an area for motion detection analysis. The button  is used for clearing all the area, and the button  is used for choosing the full screen area.
3. After selecting the area, click  to search, you will get the motion detection events easily from the long time line. Time line turns to red when motion detection events happen.
4. You can get the scene you need conveniently by moving the green vertical line or you can click  and  to move between the neighbor events.
5. You can also do the smart search in Full Screen mode, as shown in **Figure 87** by clicking  to pop-up the tool bar as .

Playing Back Pictures

Search and view captured pictures stored in HDD. To playing back pictures:

2. Enter the Picture interface, shown in **Figure 90** by going to Menu > Playback > Picture.

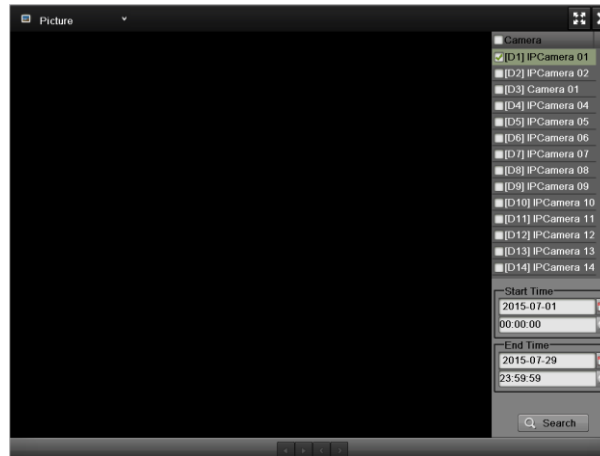



Figure 90 Picture Playback Interface

3. Select channel on Channel the dropdown list.
4. Select picture type for Continues, Event, Capture or All.
5. Select the start time and stop time.
6. Click the search button and the pictures found will be listed in Result interface.
7. Click the picture you want to view and it will be display on the preview interface.
8. Click  to choose the previous/next picture.
9. Click  to play back the pictures in Full Screen mode, as shown in **Figure 91**.

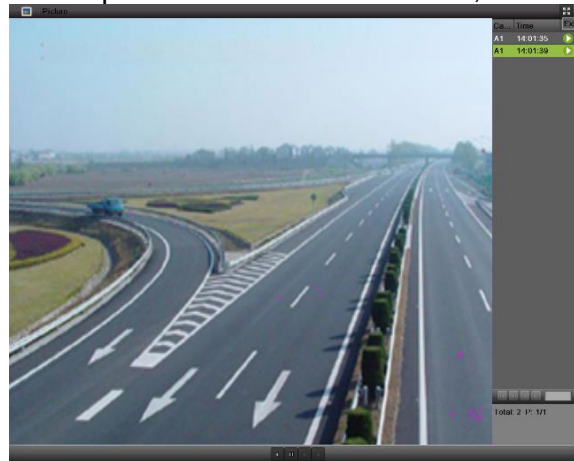

Figure 91 Picture Playback

Playing Back Tags

1. Enter the Tag interface, shown in **Figure 92** by going to Menu > Playback > Tag.

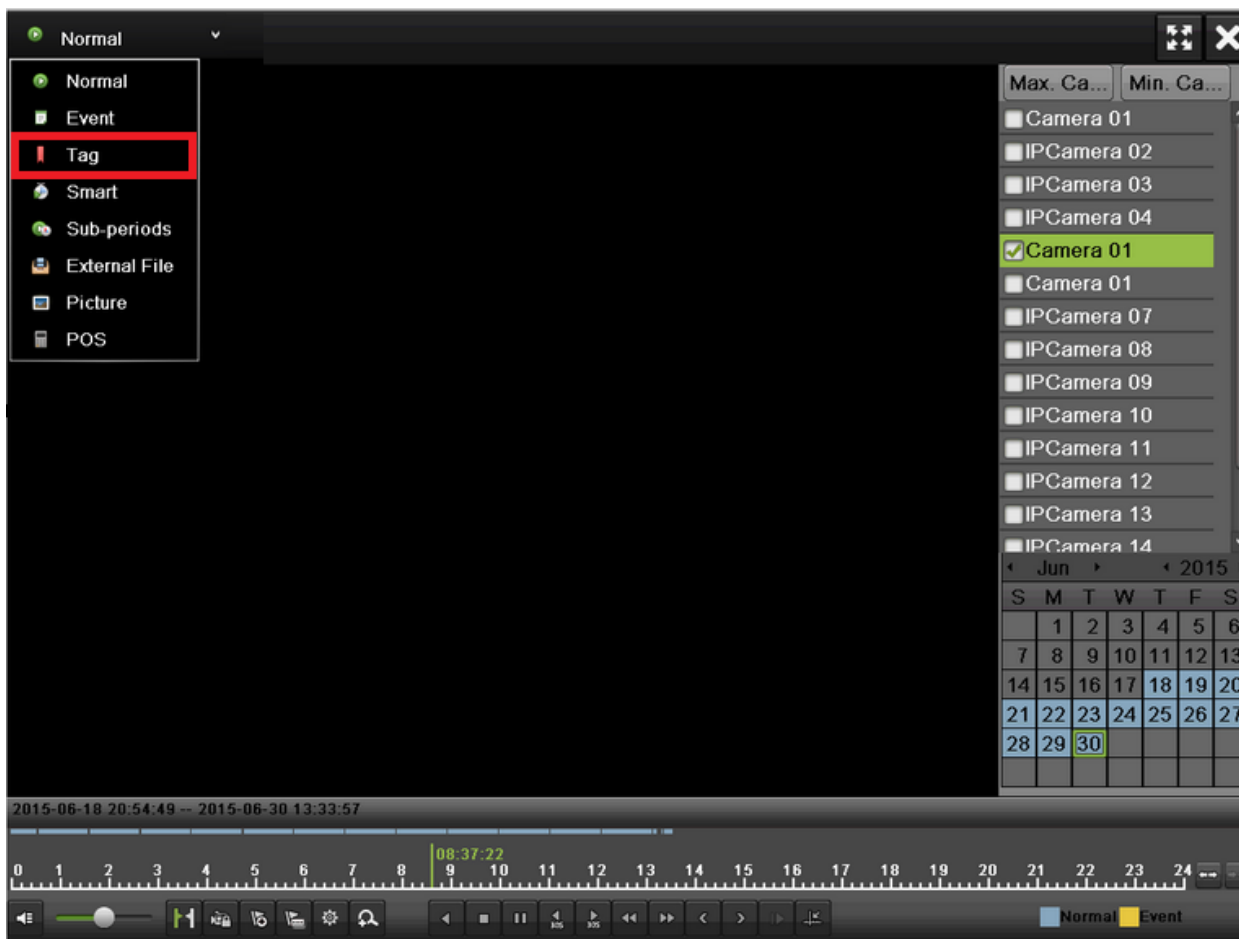



Figure 92 Tag Playback Interface

2. Select channel on the Channel dropdown list.
3. Select tag type for Tag Keyword or All.
4. If tag type was Keyword, Keyword area was editable to allow user to set keywords for fast searching.
5. Select start time and end time.
6. Select the pre-play and post-play time.
7. Click the Search button and the tag recording found will be listed in Result interface.
8. Click  or double click the tag you want to play and it will be display in the Playback interface as shown in 错误!未找到引用源。 2.
9. Drag the timeline to the place you want to play.
10. Click  to enable or disable the audio.
11. Click  to play back the pictures in Full Screen mode.
12. Click  to export selected tags.
13. Click  to export all tags.

14. Click  to edit the tag name.

15. Click  to delete the tag.

Playing Back POS events

1. Enter the POS menu, shown in **Figure 93** by going to Menu > Playback > POS.

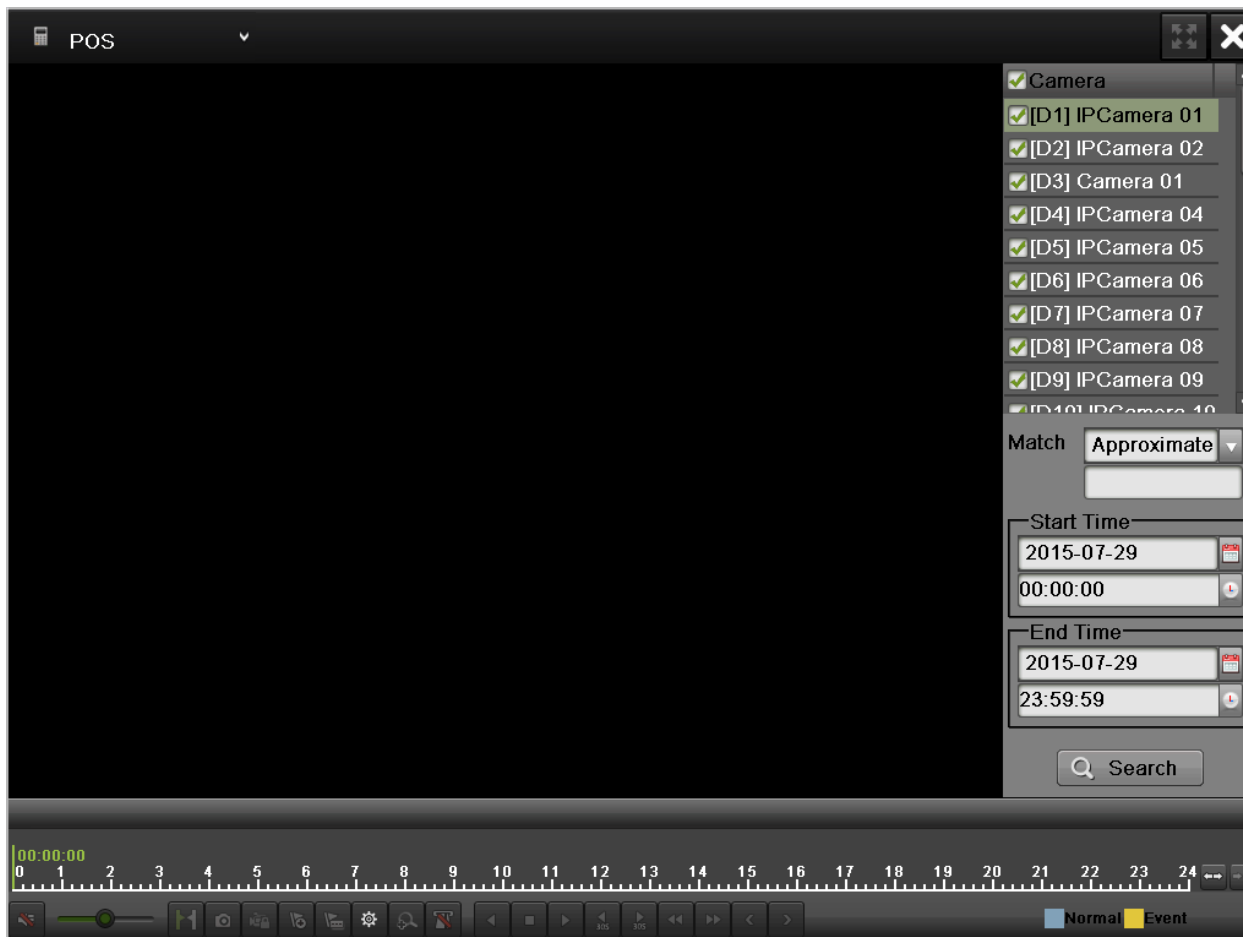

Figure 93 POS interface

2. Click on Camera to choose which channel ready to be searched.
3. Click on Match box to choose to use Approximate match or Exact match, then type in keywords to be searched in right box.

Approximate match means search results can just match to one of the keywords.

Exact match means search results should match all the keywords typed in.

4. Set the record Start Time and End Time, and the Pre-play and Post-play indicates record length of which will be displayed ahead and post of the record searched.

5. Click on Search to get the result.
6. Click on the green mark on right of result to get record played in the pink area.

Note: in small-screen playback mode, there is no POS data overlay function, please switch to full-screen playback mode to get the POS overlay function, which is enabled by default.

In full-screen mode, if you want to hide the POS information, click on the  button to disable the overlay function, as shown below.

CHAPTER 7

Backup

Backing up Video Clips

Video clips can be backed up to various devices, such as USB flash drives, USB HDDs or a DVD writer.

Selecting Video Clips

Video clips can be selected for backup in the Playback Interface using the controls found in the Mark Clip For Export panel, shown in **Figure 94**.



Figure 94 Mark Clip For Export Controls

The controls found in the Mark Clip For Export panel include:

- **Start/Stop Button:** Mark the starting/ending point for the video clip. When you click the Start, it will turn to the Stop button.
- **Play Button:** Play the selected video clip.
- **Save Button:** Save the selected video clip to the HDD.
- **Clear Button:** Clear the selected video clip.

To select video clips in the Playback Interface:

1. Enter the Playback Interface, shown in **Figure 95** by going to Menu > Playback > Record.



Figure 95 Playback Menu

2. Search for the recorded files that you would like to select video clips from (See Searching for Recorded Files on Page 60). Video clips can only be selected in single playback mode.
3. Select the starting position of the video clip by clicking the desired location on the blue recordings bar.
4. Click the Start button.
5. Select the ending position of the video clip, the same as starting position.
6. You can click  to zoom in/zoom out the timeline and select the exactly time.
7. Click the Stop button.
8. The selected video clip time range will be shown at the bottom of the Playback Interface, as seen in **Figure 96**.

Clip Time: 10:57:00 -- 10:57:55

Figure 96 Video Clip Time Range

9. You may play the video clip using the Play button or use the arrow keys , which are shown below the timeline to progress through the video one second, minute or hour at a time.
10. Click the Save button to save clip to the DVR. Clip must be first saved to the DVR before it can be backed up to an external USB storage device or to a DVD writer. Clicking the Clear button will remove the video clip.
11. Repeat steps 2-10 to select additional clips. If you would like to backup video clips at this point, click the Clips Export button.

Note:

The Play, Save and Clear buttons are not available unless a completed video clip is selected. A completed video clip has a start and end point marked by using the Start and Stop button.

Note:

The Start button is not available when there is still a video clip that has not been saved or cleared.

Backing up Video Clips

After video clips have been selected in the Playback Interface, you may back them up to an external USB storage device or DVD writer by going to the Export menu.

To backup video clips:

1. Enter the Clips Export menu, shown in **Figure 97** by first going to Menu > Playback. In the Playback menu, click the Clips Export button.

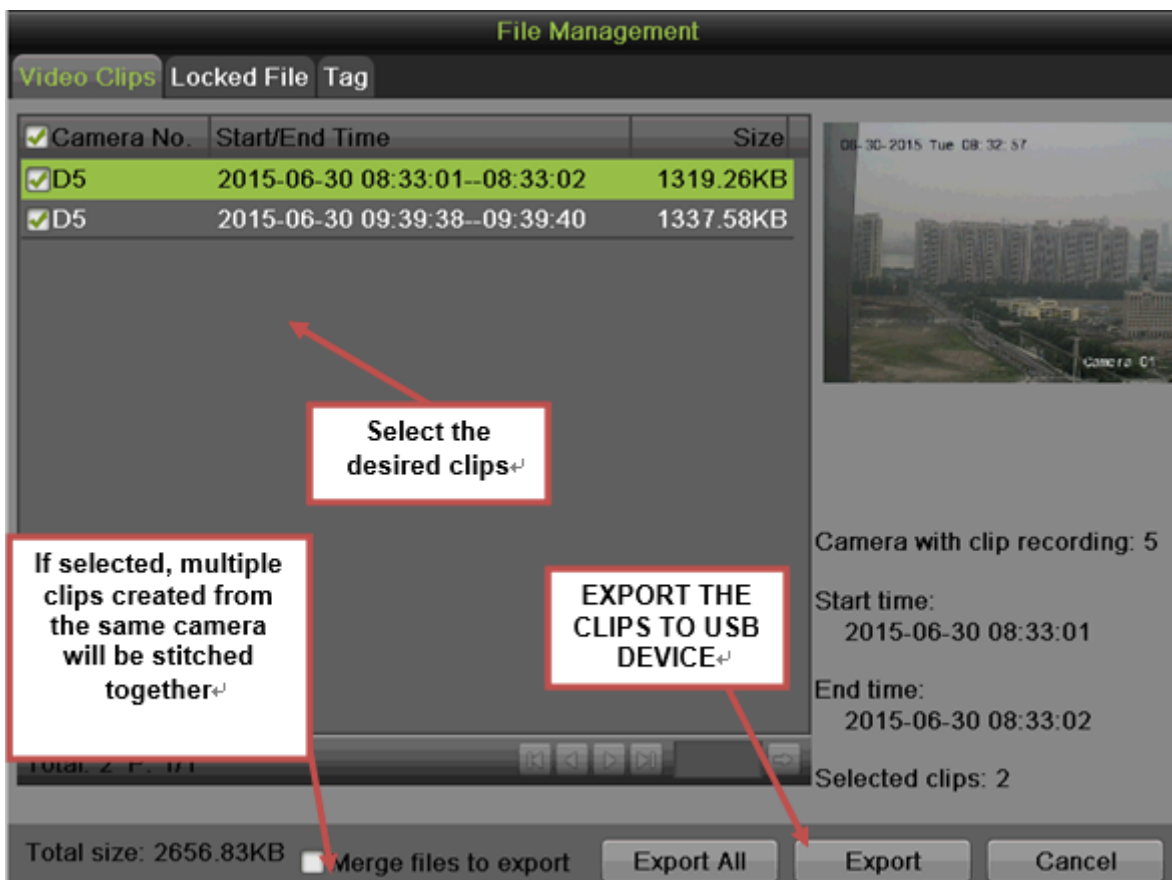



Figure 97 Clips Export Interface

- If video clips were successfully saved to the HDD using the Playback Interface, they will be listed in the Clips Export interface. The camera number as well as the time range and clip size would be listed.
- Select the video clips you would like to back up by checking the checkbox next to the desired clips. You may also click  to play and review the clip. Video clips can be deleted by clicking  or by clicking the Delete button to delete the selected clips. Check the Channel No. box will choose all clips. Check the Merge file option to merge all selected video clips and export in one video file.
- Connect at least one USB storage device to the DVR. If the device is compatible with the DVR, it will automatically be detected. Select the backup device from the Device Name dropdown menu.
- If the available space on the storage device is adequate, select the Export button to begin backup of the selected clips.
- After clips have been backed up, you may click the Cancel button to return to the Playback Interface.

Note:

If the USB storage device has not been properly initialized and formatted, you may click on the Format button to do so.

Formatting a storage device will permanently delete ALL the files on that device.

There is also NO WARNING MESSAGE after clicking the Format button to format the storage device. Please proceed with caution and backup all critical data from the storage device before formatting.

Backing up Recorded Files

Not only can video clips be backed up, full recorded files can also be backed up to a storage medium.

To back up recorded files:

1. Search for recorded files using the File Management menu (See Searching for Recorded Files on Page 60).
2. Select the files you would like to back up by checking the box next to the file. You may also check the Channel No. box to select all files. The total required space will be shown next to Total size.
3. You can also check the checkbox of Merge files to export.
4. Click the Export button; this will take you to the Export menu, as shown in **Figure 98**.

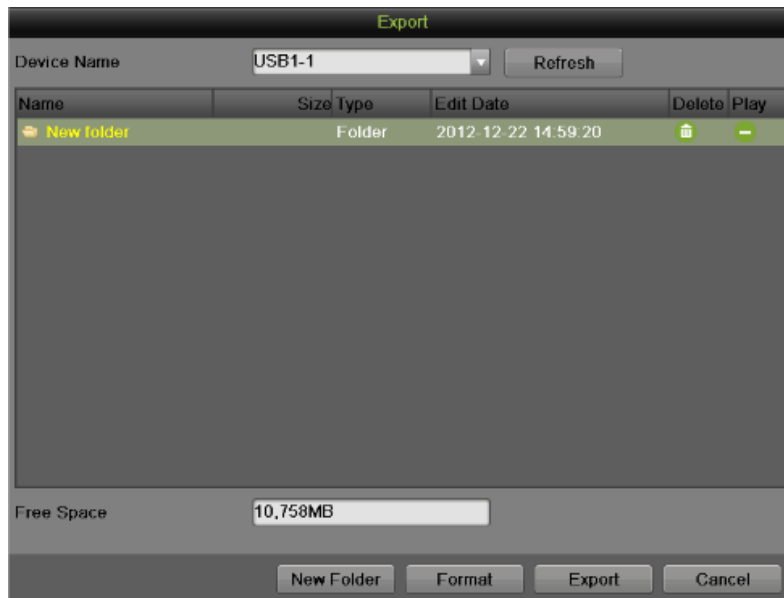

Figure 98 Files Backup Menu

5. In the Export menu, connect a USB storage device and click the Refresh button. If the device is detected, a list of its file contents as well as the available free space will be shown.
6. You may delete files on the USB storage device to free up additional storage space by clicking the Delete button on the selected file. You may also format the device by clicking the Format button. Formatting will remove ALL files from the device.
7. When there is sufficient storage space for backup, click the Export button. A backup progress bar will be shown.
8. Click the OK button once backup has completed.

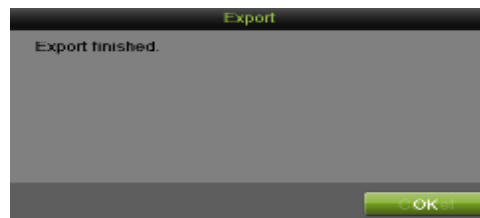

Figure 99 Export Finished Message

9. Click the Cancel button to return to the File Management menu.
10. You can also click Quick Export in the Record menu to export all the record files for the selected channel.

CHAPTER 8

System Configuration

Configuring Network Settings

Network settings must be configured before you're able to use your DVR over the network.

Configuring General Settings

To configure network general settings:

1. Enter the Network Configuration menu, shown in **Figure 100** by going to Menu > System Configuration > Network.



Figure 100 Network Settings Menu

2. Select the General tab. The current network settings are displayed on the right side of the menu, shown in **Figure 101**.

General DDNS Email SNMP NAT More Settings			
Working Mode	Net Fault-tolerance		
Select NIC	bond0	Main NIC	LAN1
NIC Type	10M/100M/1000M Self-ada		
Enable DHCP	<input type="checkbox"/>		
IPv4 Address	192.168.0.64	IPv6 Address 1	fe80::240:48ff:fe67:9f3a/64
IPv4 Subnet Mask	255.255.255.0	IPv6 Address 2	
IPv4 Default Gateway	192.168.0.1	IPv6 Default Gateway	
MTU(Bytes)	1500	MAC Address	00:40:48:67:9f:3a
DNS Server			
Preferred DNS Server			
Alternate DNS Server			

Figure 101 Network Settings Menu

3. If you have a DHCP server running and would like your DVR to automatically obtain an IP address and other network settings from that server, check the DHCP checkbox. The assigned IP information via DHCP is now displayed in the IP address bar after enable DHCP and refreshes the interface.
4. Working Mode: There are two 10M/100M/1000M NIC cards provided by the device, and it allows the device to work in the Multi-address, Load Balance and Net Fault-tolerance modes.
5. Multi-address Mode: The parameters of the two NIC cards can be configured independently. You can select LAN1 or LAN2 in the NIC type field for parameter settings. You can select one NIC card as default route. And then the system is connecting with the extranet, the data will be forward through the default route.
6. Load Balance Mode: By using the same IP address and two NIC card share the load of the total bandwidth, which enables the system to provide two gigabit network capacity.
7. Net Fault-tolerance Mode: the two NIC cards use the same IP address, and you can select the Main NIC. By this way, in case of one NIC card failure, the device will automatically enable the other standby NIC card so as to ensure the normal running of the whole system.
8. If you would like to configure your own settings, enter the settings for:
 - IP Address: IP address you would like to use for your DVR.
 - Subnet Mask: Subnet Mask of network.
 - Default Gateway: IP address of your Gateway. Typically the IP address of your router.
 - DNS Server: The preferred and alternate Domain Name System (DNS) Server to be used with your DVR.
9. Click the Apply button to save the settings.

Configuring DDNS

Dynamic DNS allows you to create a hostname and associate it to your IP address, making access to your DVR over the internet easier. To configure DDNS:

1. Select the DDNS tab to enter the DDNS settings interface, as shown in **Figure 102**.

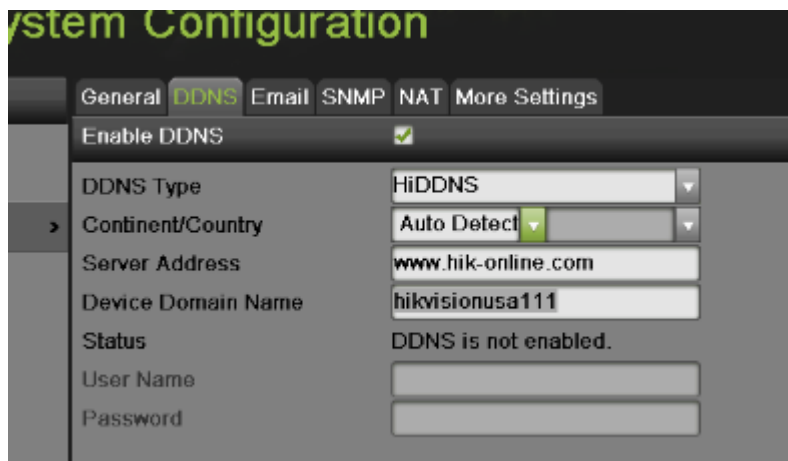

Figure 102 DDNS Settings Menu

2. Check the Enable DDNS checkbox.
3. Select a DDNS type from the DDNS Type selection box. Five different DDNS types are selectable: IPSEver, DynDNS, PeanutHull, NO-IP, hkDDNS.
 - **IPSEver:** Enter Server Address for IPSEver.
 - **DynDNS:**
 - 1) Enter Server Address for DynDNS.
 - 2) Enter the domain obtained from the DynDNS website in the Domain Name textbox.
 - 3) Enter the User Name and Password registered in the DynDNS website.
 - **PeanutHull:** Enter the User Name and Password obtained from the PeanutHull website.
 - **NO-IP:**
 - 1) Enter Server Address for NO-IP.
 - 2) Enter the domain obtained from the DynDNS website (www.no-ip.com) in the Domain Name textbox.
 - 3) Enter the User Name and Password registered in the NO-IP website.
 - **HiDDNS:**
 - 1) The Server Address defaults to www.hik-online.com.
 - 2) Enter the Device Domain Name. The domain name can only contain the lower-case letter, numeric and '-', and it must start with the lower-case letter and cannot end with '-'.
 - 3) If you have more than one device, you can register an account on www.hik-online.com to do some management.
4. Click the Apply button to save the settings.

Configuring SNMP

You can use SNMP protocol to get device status and parameters related information. To configure SNMP:

1. Select the SNMP tab to enter the SNMP settings interface, as shown in **Figure 103**.

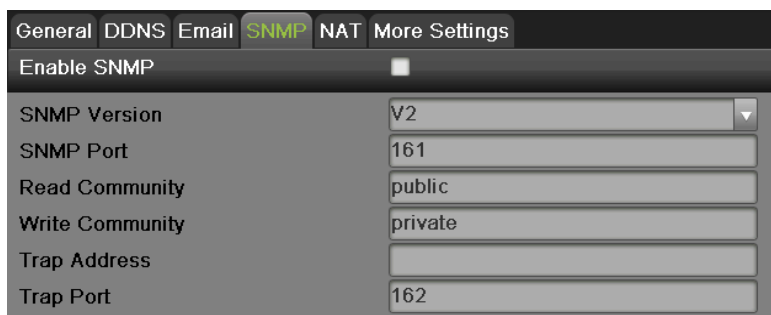

The screenshot shows the SNMP Settings Menu. At the top, there are tabs for General, DDNS, Email, **SNMP**, NAT, and More Settings. Below the tabs, there is a checkbox for 'Enable SNMP' which is currently unchecked. The settings are as follows:

SNMP Version	V2
SNMP Port	161
Read Community	public
Write Community	private
Trap Address	
Trap Port	162

Figure 103 SNMP Settings Menu

2. Check the Enable SNMP checkbox.
3. Enter the IP address of SNMP host in the Trap Address textbox.
4. Enter the port of SNMP host in the Trap Port textbox
5. Click the Apply button to save the settings.



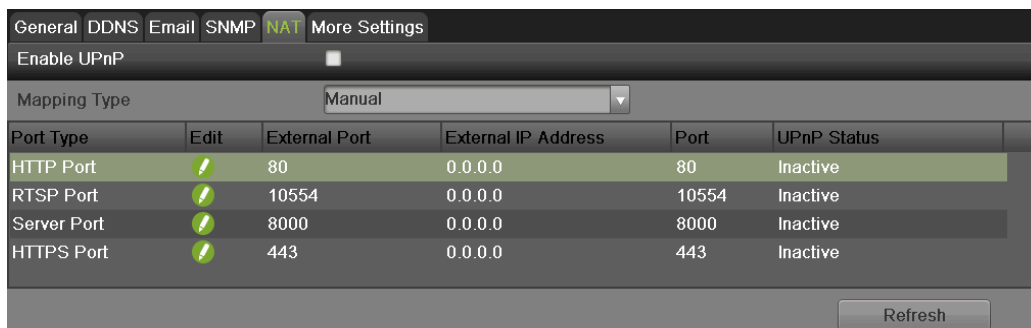

Configuring UPnP

Universal Plug and Play (UPnP) can permits the device seamlessly discover the presence of other network devices on the network and establish functional network services for data sharing, communications, etc. You can use the UPnP function to enable the fast connection of the device to the WAN via a router without port mapping. To configure UPnP:

1. Select the UPnP tab to enter the UPnP settings interface, as shown in **Figure 104**.



The screenshot shows the UPnP Settings Menu. At the top, there are tabs for General, DDNS, Email, SNMP, **NAT**, and More Settings. Below the tabs, there is a checkbox for 'Enable UPnP' which is currently unchecked. The 'Mapping Type' is set to 'Manual'. Below this is a table with the following data:

Port Type	Edit	External Port	External IP Address	Port	UPnP Status
HTTP Port		80	0.0.0.0	80	Inactive
RTSP Port		10554	0.0.0.0	10554	Inactive
Server Port		8000	0.0.0.0	8000	Inactive
HTTPS Port		443	0.0.0.0	443	Inactive

At the bottom right of the menu, there is a 'Refresh' button.

Figure 104 UPnP Settings Menu



2. Check the Enable UPnP checkbox.
3. Select the Mapped Type. There are two types:
 - **Auto**: Automatic mapping port 8000, 80, 554, 443.
 - **Manual**: Edit the port by click .
4. Click the Apply button to save the settings.

Configuring More Settings

You can configure alarm host and port by selecting the more setting tab, as shown in **Figure 105**.

General	DDNS	Email	SNMP	NAT	More Settings
Alarm Host					
Alarm Host IP	<input type="text"/>				
Alarm Host Port	<input type="text" value="0"/>				
Port					
Server Port	<input type="text" value="8000"/>				
HTTP Port	<input type="text" value="80"/>				
Multicast IP	<input type="text"/>				
RTSP Port	<input type="text" value="10554"/>				
More					
Enable High-speed Download	<input checked="" type="checkbox"/>				
Enable Telnet	<input checked="" type="checkbox"/>				

Figure 105 More Settings Menu

- 1. Alarm Host:** Send the alarm event or exception message to the alarm host when an alarm is triggered. The remote alarm host must have the CMS (Client Management System) Software installed.
 - Enter the IP address of the remote PC on which the CMS Software is installed in.
 - Enter the alarm monitoring port in Alarm Host Port, which must be the same as the port configured in the software.
- 2. Port:**
 - Server Port: Enter the Server Port which designates the port to be used with the client software.
 - HTTP Port: Enter the HTTP Port which refers to the one to be used with the built-in Web Server.
 - Multicast IP: Enter the Multicast IP to enable multicast.
 - RTSP Port: Enter the PTSP Port. PTSP is a network control protocol designed for use in entertainment and communication systems to control streaming media servers.
 - HTTPS Port: Check the Enable HTTPS checkbox and enter the HTTPS Port. HTTPS is used for secure communication over network.
- 3. More:**
 - Enable High-speed Download: Check the Enable High-speed Download checkbox. High-speed Download is used to enhance the speed of network download, but it may cause the local GUI operation to get stuck.
 - Enable Telnet: Check the Enable Telnet checkbox. Telnet is used mainly for system maintenance and debugging.
- 4.** Click Apply to save the network settings and click  to return to the previous menu. Click  without clicking Apply will quit out of the menu without saving settings.

Managing User Accounts

By default, your DVR comes with one user account, the Administrator account. The Administrator user name is admin and the password is 12345. The default password for Administrator should be changed right away for security reasons. The Administrator has the authority to add, delete or configure parameters for many of the system functions.

Changing Password

You can change the default password by going to Menu > System Configuration > User, as shown in **Figure 106**.

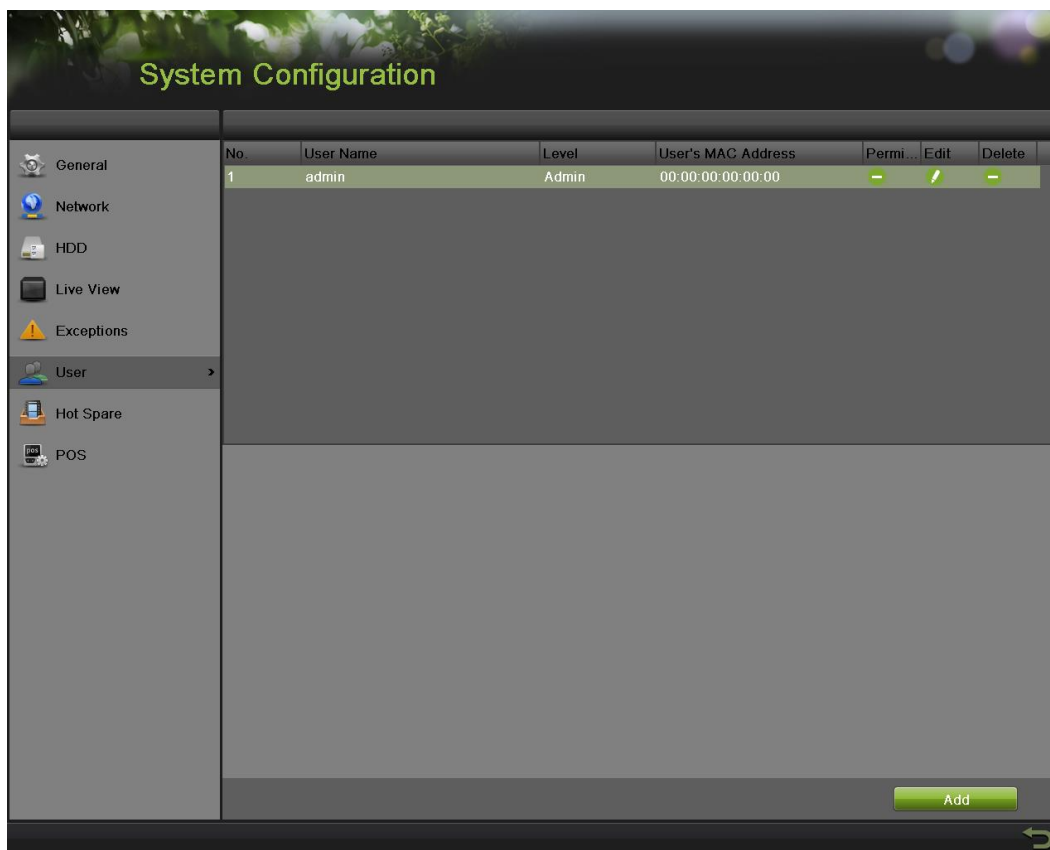
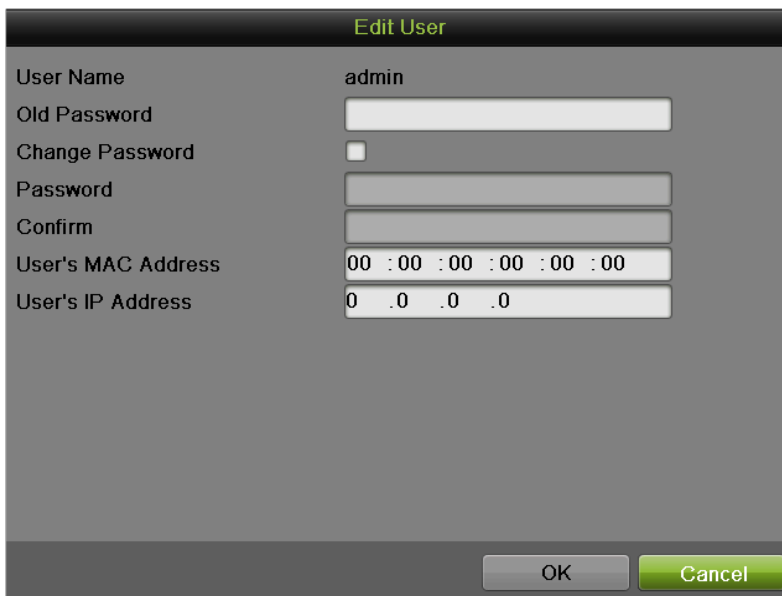

Figure 106 User Settings Menu

To change the password:

1. Click  to pop up the Edit User menu, as shown in **Figure 107**.



The screenshot shows a dialog box titled "Edit User". It contains the following fields and controls:

- User Name: admin
- Old Password: [text box]
- Change Password:
- Password: [text box]
- Confirm: [text box]
- User's MAC Address: 00 : 00 : 00 : 00 : 00 : 00
- User's IP Address: 0 . 0 . 0 . 0
- Buttons: OK, Cancel

Figure 107 Edit User Menu

2. Enter the old password in the Old Password textbox.
3. Check the Change Password checkbox.
4. Enter the new password in the Password textbox.
5. You can also enter the User's MAC or IP Address of the remote PC. If it is configured and enabled, it only allows the remote user with this MAC or IP address to access the device.
6. Click the OK button to save the setting and back to the up level.

Adding a New Remote/Local User

You may add up to 31 new users to your DVR.

To add new users:

1. On the User tab shown in **Figure 108**, click Add to enter Add User interface, as shown in **Figure 109**.

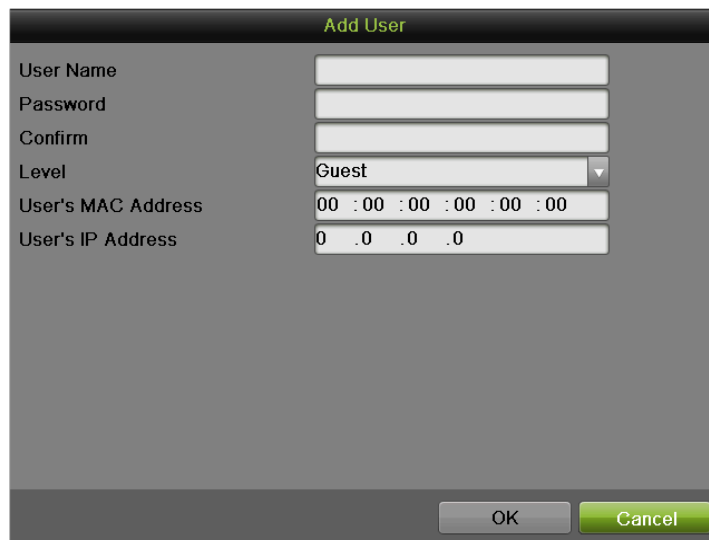

The 'Add User' dialog box contains the following fields:

- User Name: [Text Input]
- Password: [Text Input]
- Confirm: [Text Input]
- Level: [Dropdown Menu] (Current selection: Guest)
- User's MAC Address: [Text Input] (Default: 00 : 00 : 00 : 00 : 00 : 00)
- User's IP Address: [Text Input] (Default: 0 . 0 . 0 . 0)

Buttons: OK, Cancel

Figure 108 Add User Menu

- Enter the information for new user, including User Name, Password, Level and User's MAC or IP Address.
Level: Set the user level to Guest or Operator. Different user levels have different default operating permission.
 - Guest:** Guest has the default permission of local log search and remote log search.
 - Operator:** Operator has the default permission of local log search, remote log search, two-way audio and camera configuration.
- Click the OK button to confirm adding the user. Once a new user has been created, the fields behind Users will become editable, as shown in **Figure 108**.



The 'System Configuration' window shows the 'User' settings menu. The table below represents the data shown in the table:

No.	User Name	Level	User's MAC Address	Permi	Edit	Delete
1	admin	Admin	00:00:00:00:00:00	-	/	-

Figure 109 User Settings Menu

Changing the permission of User

The Administrator can change the permission of both guest and operator. To change the permission:

- Enter the User menu, shown in **Figure 109** by going to Menu > System Configuration > User.
- Click  to enter the Permission interface, as shown in **Figure 110**.

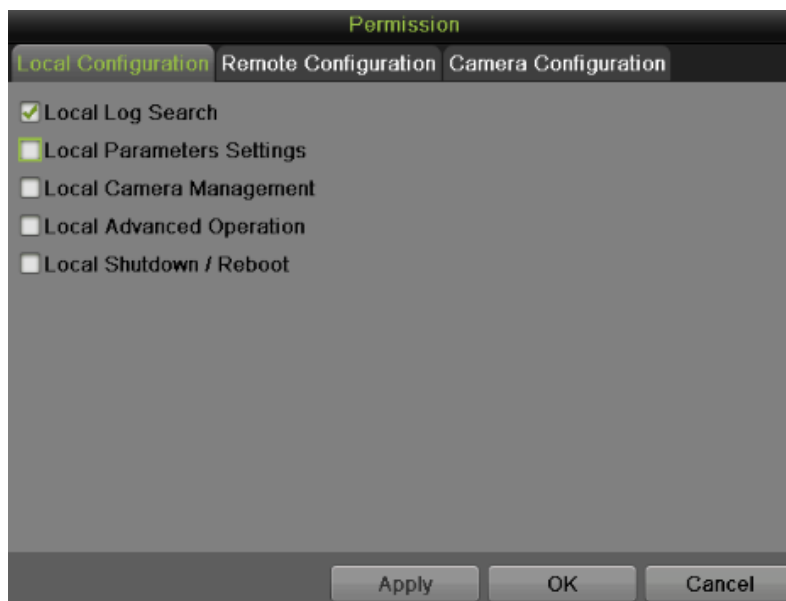

Figure 110 Permission Settings Menu

3. Set the operation permission of Local Configuration, Remote Configuration and Camera Configuration for the user.

Local Configuration:

- Local Log Search: Searching and viewing logs and system information of DVR.
- Local Parameters Settings: Configuring parameters, restoring factory default parameters and importing/exporting configuration files.
- Local Camera Management: Enabling and disabling analog camera(s). Adding, deleting and editing of network camera(s).
- Local Advanced Operation: Operating HDD management upgrading system firmware, clearing I/O alarm output.
- Local Shutdown/Reboot: Shutting down or rebooting the DVR.

Remote Configuration:

- Remote Log Search: Remotely viewing logs that are saved on the DVR.
- Remote Parameters Settings: Remotely configuring parameters, restoring factory default parameters and importing/exporting configuration files.
- Remote Camera Management: Remotely enabling and disabling analog camera(s), and adding, deleting and editing of network camera(s).
- Remote Serial Port Control: Configuring settings for RS-232 and RS-485 ports.
- Remote Video Output Control: Sending remote button control signal.
- Two-Way Audio: Realizing two-way radio between the remote client and the DVR.
- Remote Alarm Control: Remotely arming (notify alarm and exception message to the remote client) and controlling the alarm output.
- Remote Advanced Operation: Remotely operating HDD management upgrading system firmware, clearing I/O alarm output.
- Remote Shutdown/Reboot: Remotely shutting down or rebooting the DVR.

Camera Configuration:

- Local Video Export: Locally exporting recorded files of the selected camera (s).
- Local Playback: Locally playing back recorded files of the selected camera (s).
- Local PTZ Control: Locally controlling PTZ movement of the selected camera (s).
- Local Manual Operation: Local manual operation of the selected camera (s).
- Remote Live View: Remotely viewing live video of the selected camera (s).
- Remote Playback: Remotely playing back recorded files of the selected camera (s).
- Remote PTZ Control: Remotely controlling PTZ movement of the selected camera (s).
- Remote Manual Operation: Remotely manual operation of the selected camera (s).

4. Click the Apply button to save the parameters.

Note:

If you forget the password to your DVR, contact your supplier with the serial number of your DVR to obtain a secure code to reset your DVR.

Note:

User settings only appear on the list of System Configuration when login with Administrator accounts.

Deleting a User

To delete a user from the DVR:

1. Enter the User menu, shown in **Figure 109** by going to Menu > System Configuration > User.
2. Select a user and click  to delete.
3. Click the Yes button to confirm the deletion of user or click the No button to cancel.

Editing a User

To edit a user:

1. Enter the User menu, shown in **Figure 110** by going to Menu > System Configuration > User.
2. Select a user and click  to edit user.
3. Edit user information including user name, password, level and MAC address.
4. Click the OK button to save and exit.

Note:

User password can be both numbers and characters. You can click the button  on the password editable fields to enter characters.

Switch User

On the main menu (see in **Figure 111**), information about users are show on the lower left

corner,   User: admin, click  to switch users.



Figure 111 Main Menu

Resetting Password

To reset passwords with the new Hikvision Secure Password Strategy, you must use SADP Tools software (v2.2.3.5 Build 20150408) or later (Figure 112). It can be downloaded from our download portal at Helpdesk.usa@hikvision.com. It can be used on front-end and back-end devices with firmware shown in the following table:

Device Firmware with Secure Activation

Device Type	Model Number	Firmware Version
Value Series IP Camera	DS-2CD2xxx	V5.3.0
Smart Series IP Camera	DS-2CD4xxx	V5.3.0
NVR/Hybrid	DS-9016HWI-ST DS-96xxNI-ST DS-7716NI-SP/16	V3.1.5
Plug-n-Play NVR	DS-76xxNI-EI(E2)/P	V3.1.0
Turbo DVR	DS-72xxHGHI-SH DS-73xxHQHI-SH	V3.1.6
Super NVR	DS-96128NI-E24/H DS-96256NI-E24/H	TBD



Figure 112 You need to download a new version of the SADP Tool software (v2.2.3.5 Build 20150408)

NOTE: Once you update your DVR/NVR or camera firmware, it **cannot** be downgraded to a previous version; the upgrade **is not** reversible.

By using the new SADP Tool you can determine if the front-end device is using **OLD** or **NEW** firmware. If your device has old firmware v3.1.0 (Figure 113), you'll need to reset the password by using the old procedure. With the new firmware v3.3.0 (Figure 114), the default username and password (*admin*, *12345*) are no longer applicable. The user will be prompted to assign a new password during the initial password reset attempt.

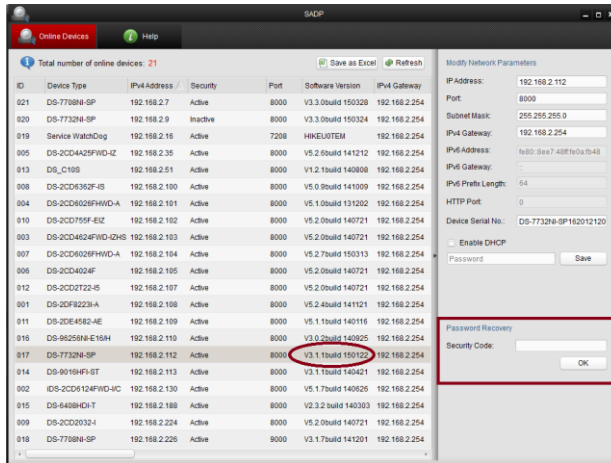

Figure 113 New SADP Tool lets you determine if front-end device is using OLD firmware (V3.1.0build 150122 shown)...

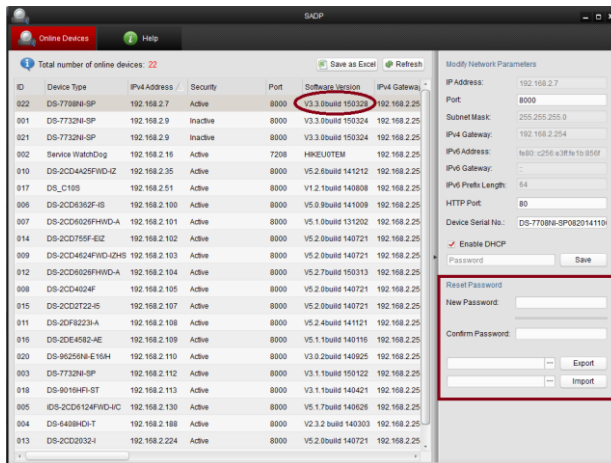

Figure 114...or NEW firmware (V3.3.0build 150328 shown)

1. To request a password reset code, create a folder on your PC (Figure 115) into which to export the *.XML file.

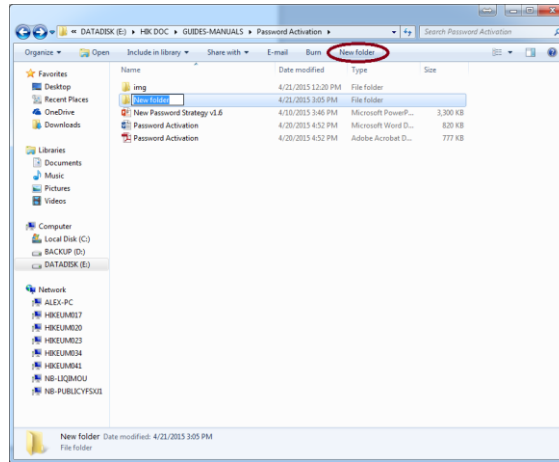

Figure 115 Create a new folder into which to export the *.XML file

2. Open the SADP Tool and highlight the device for which you need a recovery code. Click the **[Browse]** (...) button (Figure 116).

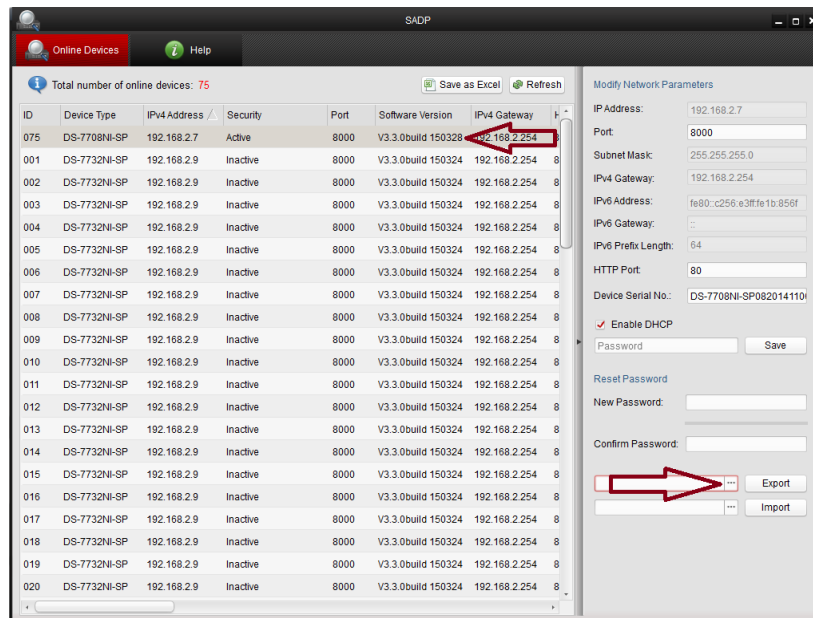

Figure 116 Click the **[Browse]** (...) button

3. Select the directory path to the folder you've created and click **[Choose]** (Figure 117).

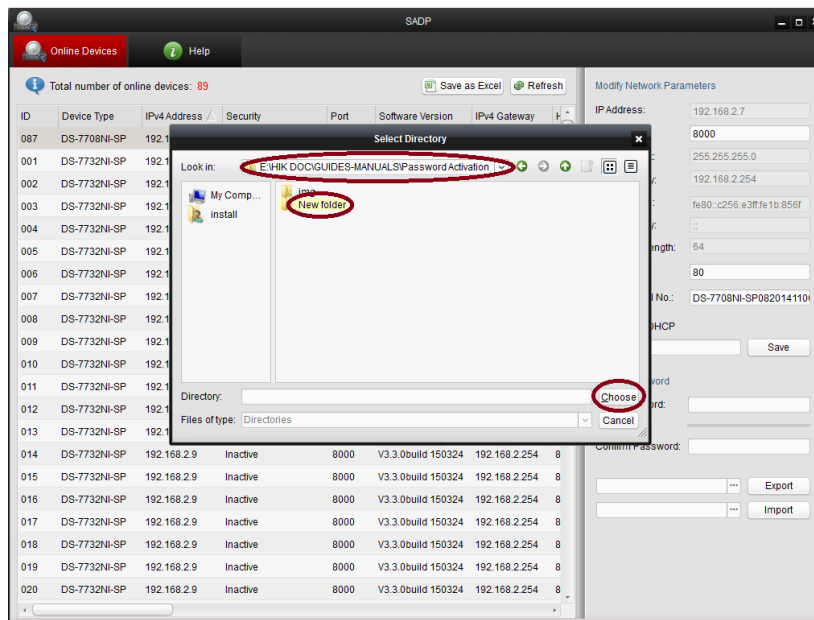

Figure 117 Select directory path and click [Choose]

4. Click **[Export]** (Figure 118) and a file named “DeviceKey.xml” will be generated.
5. Send this “DeviceKey.xml” file to Passwordreset@hikvisionusa.com as an e-mail attachment.

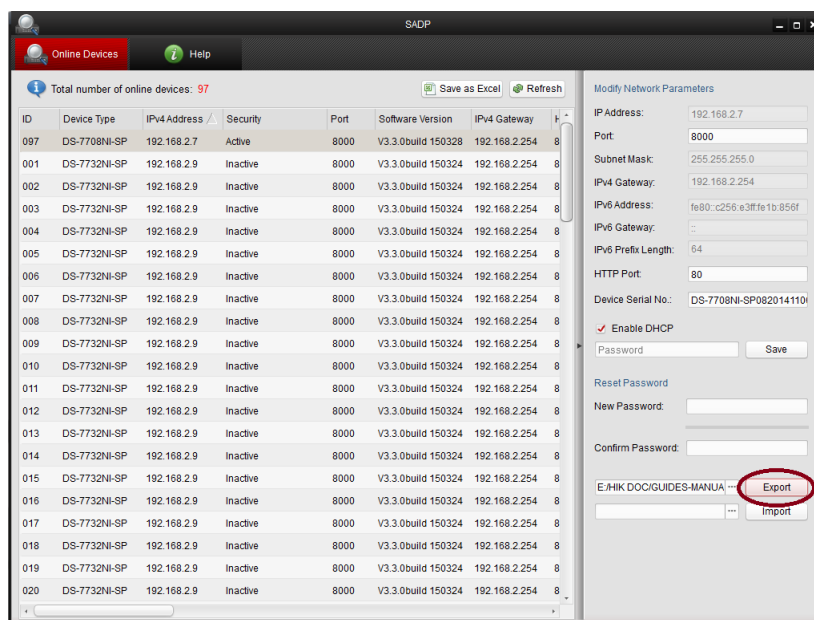

Figure 118 Click [Export] and a file named “DeviceKey.xml” will be generated

6. Once you send the “DeviceKey.xml” file, you’ll receive an encrypted file named ‘Encrypt.xml’ back via e-mail in approximately 24 hours. Save this file in the same folder you’ve previously saved the “DeviceKey.xml” (Figure 119). You’ll need the path to import the encrypted key later on.

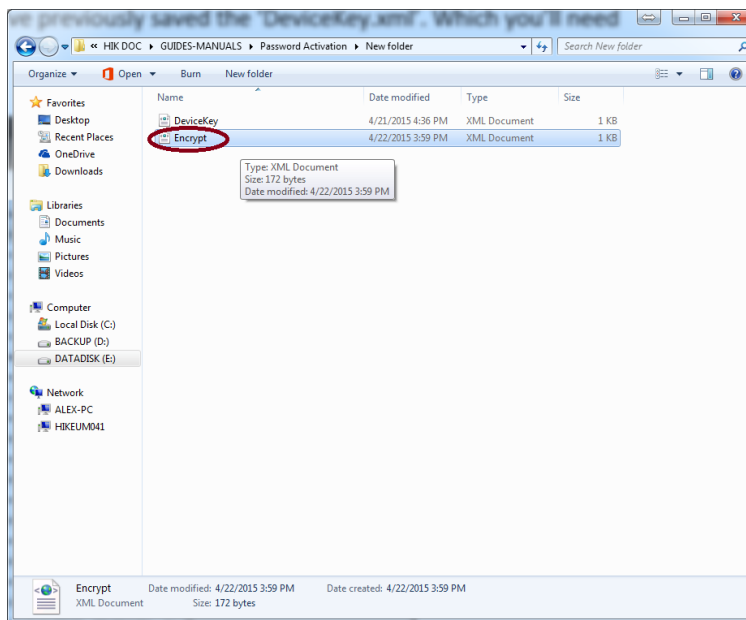

Figure 119 Save this file in same folder where you've saved "DeviceKey.xml"

7. In the SADP Tool, highlight the device again, click **[Browse]** (...), and select the path where you saved the "Encrypt.xml" file (Figure 120).

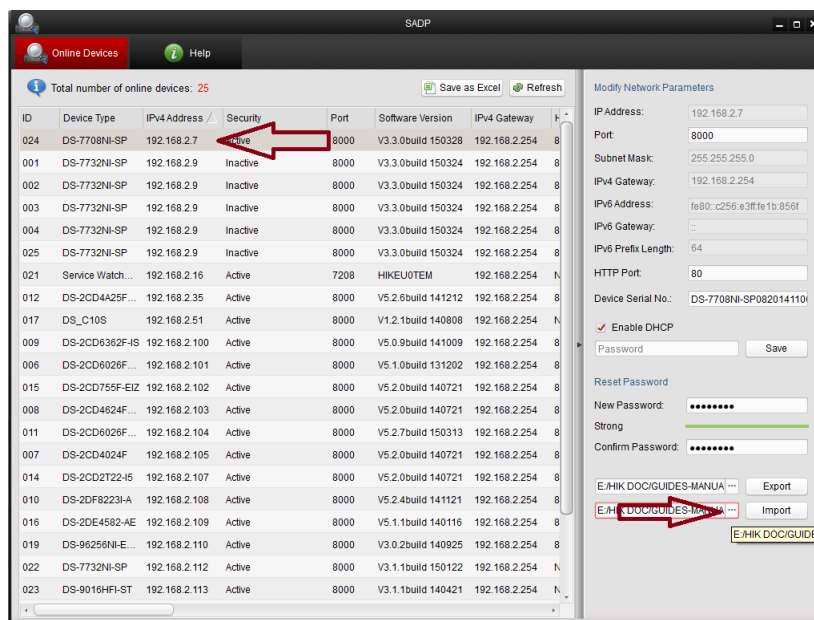

Figure 120 Select device again and click [Browse] to locate the path where you saved the "Encrypt.xml" file

8. Create a password of your choice by entering a new password into the "New Password" field on the bottom right of the screen (Figure 123). See "Reference" section on page 15 for guidelines.
9. Retype the password into the "Confirm Password" field.

- After the password has been entered and confirmed, click **[Import]** (Figure 121) to import the "Encrypt.xml" file you received and saved from Hikvision Technical Support.

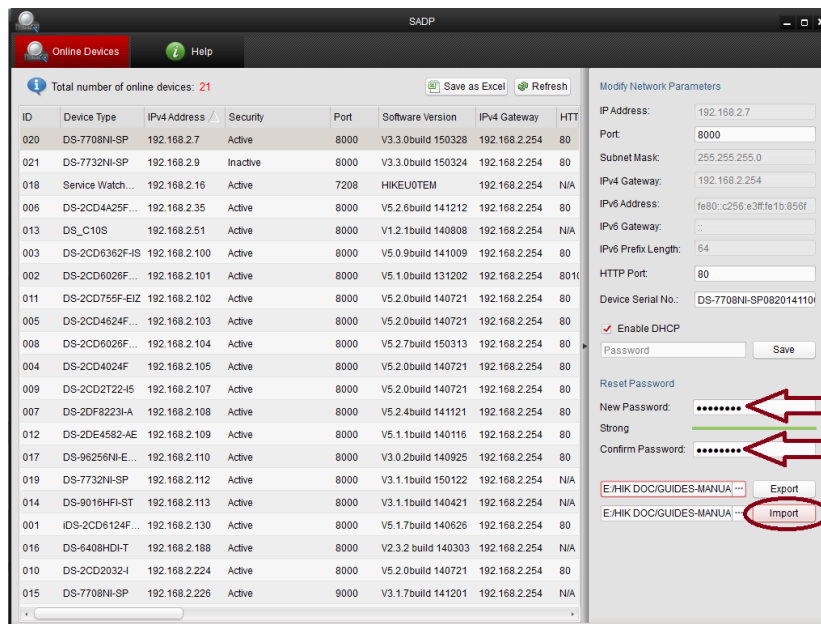

Figure 121 Set up a password by clicking [New Password] and [Confirm Password], then click [Import]

- A "Reset password succeed" message will appear (Figure 122).
- Press the "X" in the top right corner of the pop-up confirmation window to dismiss the window.

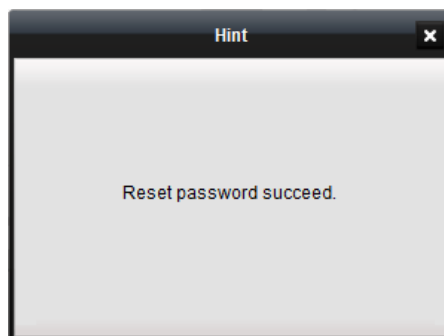

Figure 122 "Reset password succeed" message will appear

Reference: Password Strength Requirements

Hikvision's new login procedure requires users to create a new password for the **admin** account upon the first login to all devices. The password must contain 8 to 16 characters, combining numbers, lowercase letters, uppercase letters, and special characters. At least two types of the above-mentioned characters are required. The system will check the password strength; "Risky" passwords will not be accepted.

- The password strength will be displayed, accompanied by a color indicator*:
 - Level 0—*Risky* (no indicator): Not acceptable
 - Level 1—*Weak* (pink indicator): Acceptable
 - Level 2—*Medium* (yellow indicator): Acceptable
 - Level 3—*Strong* (green indicator): Acceptable
- Bar length indicates strength level.
- Activation will not be allowed unless the password is of acceptable strength ("Weak," Figure 125, "Medium," Figure 126, or "Strong," Figure 127). If the password is of unacceptable strength ("Risky," Figure 123), a warning box will be displayed (Figure 124).

Password Strength Levels

STRENGTH LEVEL	DESCRIPTION
Level 0 (Risky) Cameras <i>will not</i> accept a Level 0 password	Password length is fewer than eight characters, contains only one type of character, is the same as the user name, and/or is the mirror writing of the user name. This type of password <i>will not</i> be accepted.
Level 1 (Weak) Cameras <i>will</i> accept a Level 1 password	Password contains two types of characters. The combination is number + lowercase letter or number + uppercase letter, and the password length is at least eight characters. This type of password <i>will</i> be accepted.
Level 2 (Medium) Cameras <i>will</i> accept a Level 2 password	Password contains two types of characters. The combination is neither number + lowercase letter <i>nor</i> number + uppercase letter, and the password length is at least eight characters. This type of password <i>will</i> be accepted.
Level 3 (Strong) Cameras <i>will</i> accept a Level 3 password	Password contains more than three types of characters, and the password length is at least eight characters. This type of password <i>will</i> be accepted.

*NOTE: The strength level indicator colors can vary by activation process, model number, and device type.

NOTE: Types of characters are lowercase letters, uppercase letters, numbers, and special characters. Only ASCII characters are allowed.

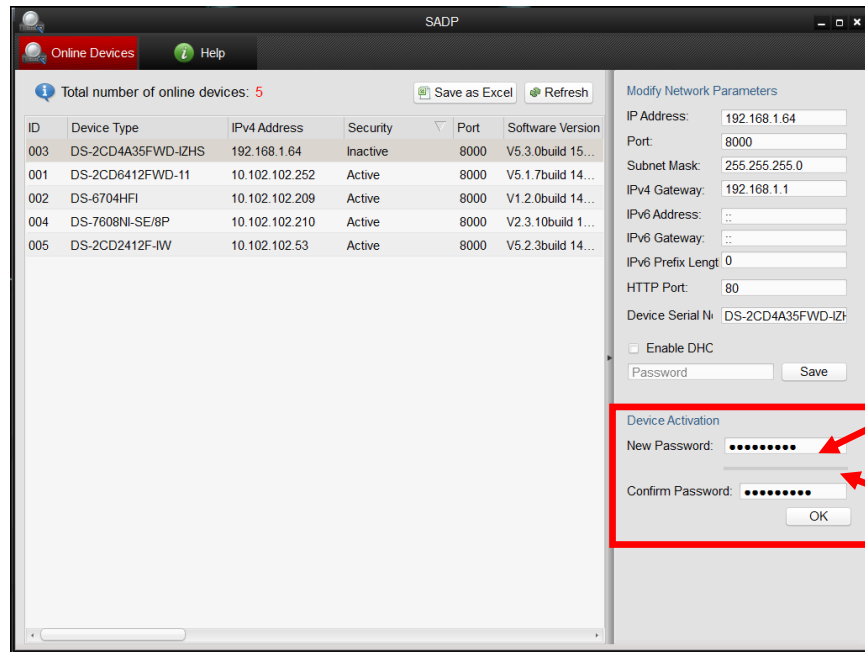

Figure 123 Password Field with "Risky" Unacceptable Password

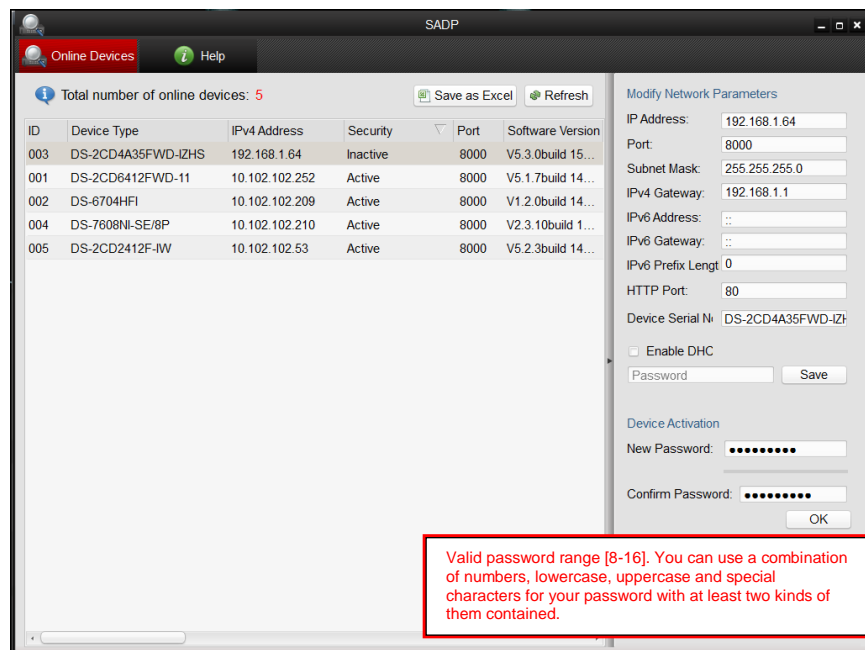

Figure 124 "Risky" Unacceptable Password Warning Message

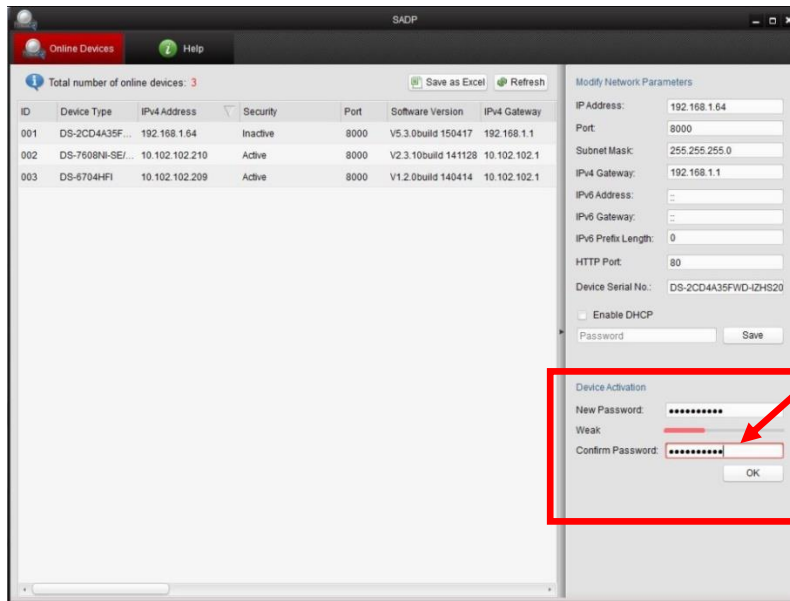

Figure 125 Password Field with Acceptable “Weak” Strength Password

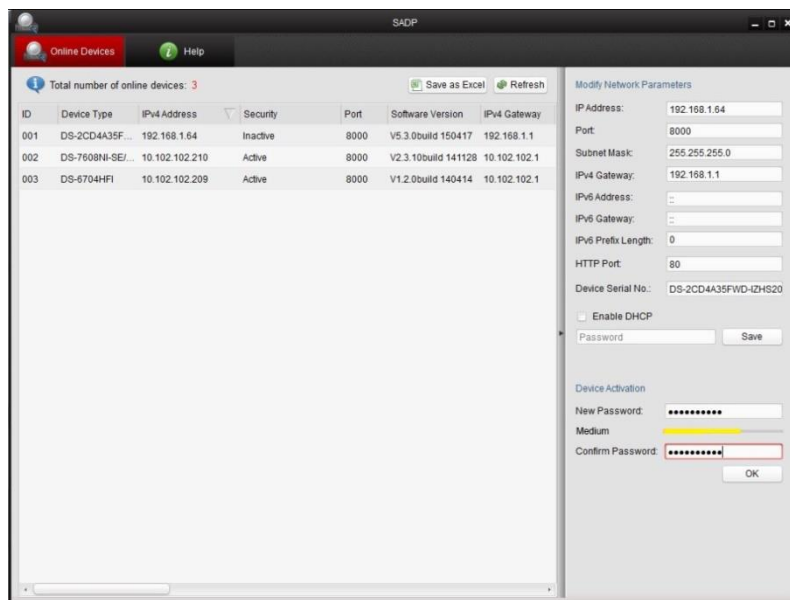

Figure 126 Password Field with Acceptable “Medium” Strength Password

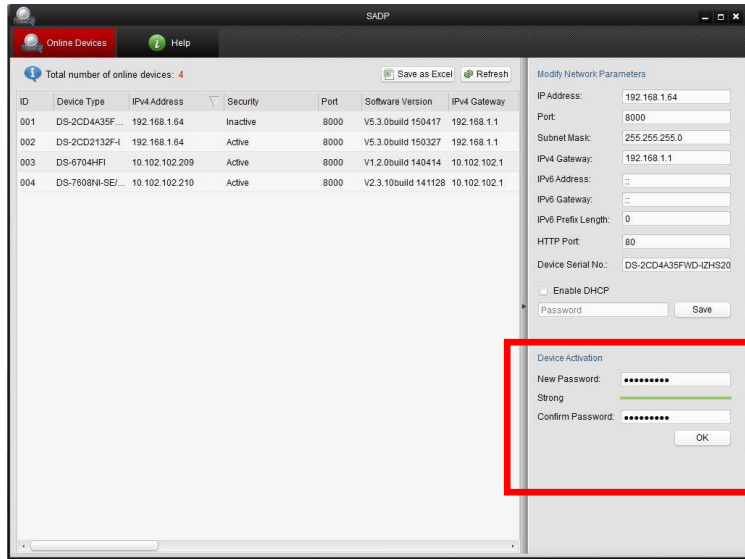

Figure 127 Password Field with Acceptable “Strong” Strength Password

Configuring PTZ Cameras

Configuring Basic PTZ Settings

Settings for a PTZ camera must be configured before it can be used. Before proceeding, verify that the PTZ and RS-485 of the DVR are connected properly.

To configure PTZ settings:

1. Enter the PTZ menu, shown in **Figure 128** by going to Main Menu > Cameras Setup > PTZ.



Figure 128 General Settings of PTZ Configuration

2. Select the General tab.
3. Select the camera to configure in the Camera dropdown list.
4. Configure PTZ settings, including those of Baud Rate, Data Bit, Stop Bit, Parity, Flow Ctrl, PTZ Protocol and Address according to the parameters of the PTZ camera(s).
5. If the same configuration can be applied to other PTZ channels, click the Copy button.
6. Click the Apply button to save the settings.

To test and verify PTZ settings:

1. Enter the PTZ Configuration menu by going to Menu > Cameras Setup > PTZ.
2. Select the More Settings tab, shown in **Figure 129**.



Figure 129 More Settings of PTZ Configuration

3. Select the camera to test in the Camera dropdown list.
4. Using the Directional buttons and other PTZ control buttons (Zoom +/-, Focus +/-, the speed of the PTZ movement), test the functionality of the PTZ camera. If PTZ camera and protocol supports it, you may also click the Auto-Scan button to test its function. PTZ controls buttons are shown in **Figure 130**.

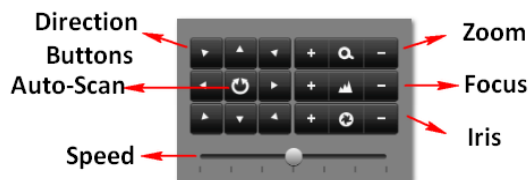

Figure 130 PTZ Controls Button

5. If PTZ camera is not working properly, make sure PTZ is connected and configured with the correct settings under the General tab.

Customizing PTZ Presets, Patterns and Patrols

Your DVR allows you to customize presets, patterns and patrols for a connected PTZ camera. A PTZ camera must first be configured before PTZ presets, patterns and patrols can be customized (See Configuring Basic PTZ Settings).

To customize PTZ presets:





1. Enter the PTZ menu by going to Menu > Cameras Setup > PTZ.
2. Select the More Settings tab, as shown in **Figure 129**.
3. Select Save Preset and move the camera to the desired position using the PTZ control buttons.

4. Double-click on a preset number. The current position of the PTZ camera will be set for the selected preset number.
5. To test the newly configured preset, first move the PTZ camera to a different position. Select Recall Preset and click on the preset number. The camera should move to the location that was set for the selected preset number.
6. Repeat the steps to save more presets.



Note:

Only the first 17 presets are shown in the table. To save or recall more presets, click on the “...” button. Clicking the “...” button will bring up a selection box for presets up to 255.

To customize PTZ patterns:

1. Enter the PTZ menu by going to Menu > Cameras Setup > PTZ.
2. Select the More Settings tab, as shown in **Figure 129**.
3. Select a Pattern Number to set from the dropdown list.
4. Click  to begin recording the movement of the PTZ.
5. Move the PTZ to the desired locations using the PTZ control buttons.
6. Click  to save pattern.
7. To test out your new pattern, click  to play and  to stop. The PTZ should move as it did during the recording process. You may click the stop button at any time to end the pattern. Clicking the play button again will start playing the PTZ pattern again at the initial position.

To customize PTZ patrols:

1. Enter the PTZ menu by going to Menu > Cameras Setup > PTZ.
2. Select the More Settings tab, as shown in **Figure 129**.
3. Select a Patrol Number to set from the dropdown list.
4. Click  to pop-up a KeyPoint box and add key point. Select a Preset Number from the dropdown list that you would like to add to the patrol. Set the duration and speed.
5. Click the OK button. The Preset Number will be added to the patrol list.
6. Repeat steps 4-5 until you have included all the presets you would like to have on the patrol.
7. Click the Up and Down button at the bottom of the list to change the order of the presets in the patrol.
8. To test out your new preset, click the Play and Stop button, shown as . The PTZ should move through the list of added presets and end the patrol when you click Stop.

Configuring Alarms and Exceptions

Setting up Motion Detection

Set up properly, using motion detected recording will increase the number of days your DVR is able to record. It will only record relevant events rather than everything, which will also make searching for events easier.

To set up motion detection:

1. Enter the Motion Detection menu, shown in **Figure 131** by going to Menu > Recording Configuration > Motion Detection.



Figure 131 Motion Detection Settings Menu

2. Select the camera to configure in the camera dropdown list.
3. Check the Enable Motion Detection checkbox to enable motion detection for the selected camera. Uncheck the checkbox to disable motion detection.
4. Set the motion detection sensitivity by adjusting the green Sensitivity bar. The more lime green rectangles selected in the bar, the higher the sensitivity will be to motion.
5. Set the motion detection region in the preview screen on the right side of the menu by left-clicking with the mouse on an open area. A red grid will be shown, designating that the selected area is part of the motion detection region. Dragging or left-clicking on areas that overlap the current selected motion detection area will include them into the region. You may also click the Full Screen button to include the whole area into the motion detection region. Left-clicking on any part of the grid will remove that section from the motion detection region.
6. If you're not satisfied with the selected region, you may click the Clear button to reset the motion detection area.

7. Select the actions to take if motion is detected in the designated regions. Click the Set button to pop up the Handling menu.

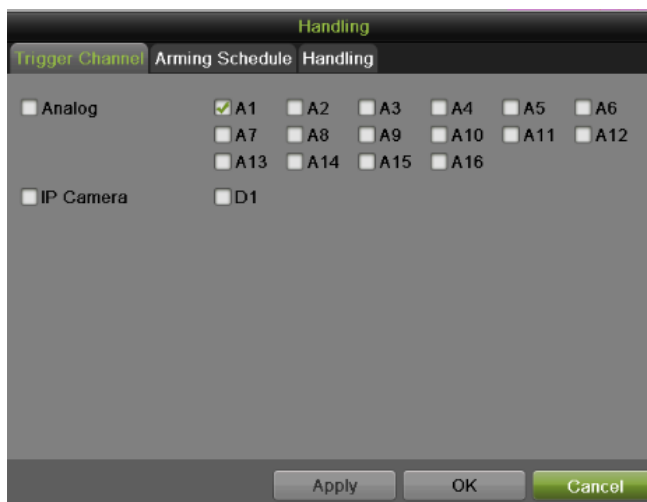

Figure 132 Trigger Channel Settings Menu

- 1) Select the Trigger Channel tab and check the checkbox of channels which you want the motion detection event to trigger recording. Click Apply to save the setting.
- 2) Select the Arming Schedule tab, as shown in **Figure 133**. Choose one day in a week and set an arming schedule. If the schedule can also be applied to other days, click Copy. Click the Apply button to save the settings.



Figure 133 Arming Schedule Settings Menu

- 3) Select the Handling tab, as shown in **Figure 134**.

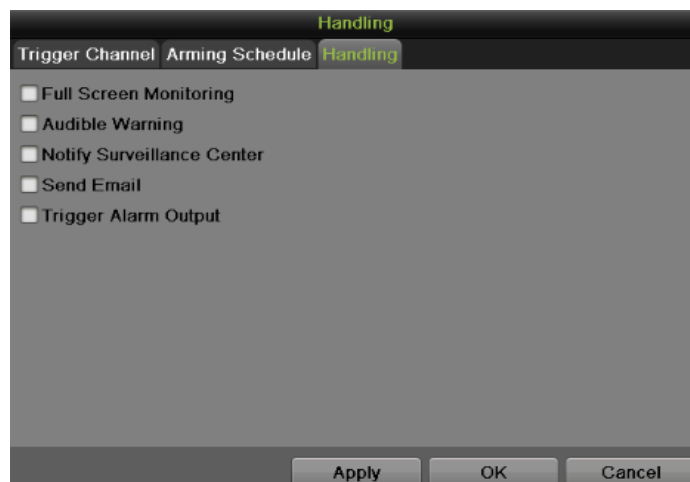

Figure 134 Handling Settings Menu

To set other actions, including:

- **Full Screen Monitoring:** DVR will display the video image in full screen when motion is detected.
- **Audible Warning:** DVR will sound an audio warning if motion is detected in the designated regions of the camera.
- **Notify Surveillance Center:** DVR will notify surveillance center when motion is detected.
- **Send Email:** DVR will send an email out to the designated recipients when motion is detected. Please refer to configure email settings on Page 91 for details.
- **Trigger Alarm Output:** DVR will trigger alarm output when motion is detected. When you check the Trigger Alarm Output checkbox, there will display a choose box to select Alarm Output No., as shown in **Figure 135**.



Figure 135 Trigger Alarm Output Settings Menu

8. Select the Apply button to save the motion detection settings and select OK to return to the previous menu. Selecting the Cancel button without clicking Apply or OK will quit out of the menu without saving settings.

Configuring Alarm Inputs

Certain actions can also be performed if an alarm input is triggered. To setup trigger actions:

1. Enter the Trigger menu, shown in **Figure 136** by going to Menu > Recording Configuration > Trigger.



Figure 136 Trigger Settings Menu

2. Select the Alarm Input tab.
3. Select the Alarm Input No. in the dropdown list.
4. Edit the Alarm Name.
5. Select the trigger Type for the external alarm input device. N.O means Normal Open. N.C means Normal Close. These two types can be selected.
6. Check the Enable Alarm Input checkbox to enable the selected alarm input. Uncheck the checkbox to disable alarm input.
7. Click Handling Set to pop-up the Handling menu, as shown in **Figure 137**.

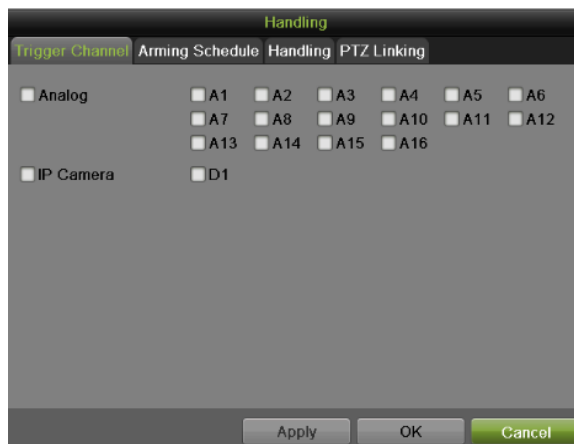

Figure 137 Trigger Channel Settings Menu

- 1) Select the Trigger Channel tab and check the checkbox of channels which you want the alarm to trigger recording. Click Apply to save the settings.
- 2) Select the Arming Schedule tab. Choose one day in a week and set an arming schedule. If the schedule can also be applied to other days, click Copy. Click Apply to save the settings.
- 3) Select the Handling tab which is same as **Figure 137** to set other actions. Click Apply to save the settings.
- 4) Select the PTZ Linking tab, as shown in **Figure 138**, to set the PTZ actions (only if a PTZ camera is configured on the DVR). Only one PTZ action can be selected per alarm input.



Figure 138 PTZ Linking Settings Menu

8. If the same settings can be applied to other alarm inputs, click the Copy button to copy the settings to others.
9. Click Apply to save the settings.
10. You can check the alarm input status in the Alarm Input Status list on the Alarm Input Interface.

Configuring Alarm Outputs

Trigger an alarm output when an alarm is triggered. To configure alarm output:

1. Enter the Trigger menu by going to Menu > Recording Configuration > Trigger.
2. Select the Alarm Output tab, as shown in **Figure 139**.



Figure 139 Alarm Output Settings Menu

3. Select the Alarm Output No. in the dropdown list.
4. Edit the Alarm Name.
5. Select the Dwell Time.
6. Setup arming schedule for the alarm output by click Handling Set. Choose one day in a week and set an arming schedule. If the schedule can also be applied to other days, click Copy. Click Apply to save the settings and back to the Alarm Output interface.
7. If the same setting can also be applied to other alarm output, click Copy.
8. Click Apply to save the settings.
9. You can check the alarm output status in the Alarm Output Status list in the Alarm Output interface.

Configuring Exceptions



Actions can also be triggered when the DVR detects certain exceptions. To setup exception configuration:

1. Enter the Exception menu, shown in **Figure 140** by going to Menu > System Configuration > Exception.



Figure 140 Exception Configuration Menu

2. Select the Exception Type to configure. The exception types include:
 - **HDD Full:** If selected, trigger action when HDD is full.
 - **HDD Error:** If selected, trigger action when errors on the HDD are detected.
 - **Network Disconnected:** If selected, trigger action when a network disconnected is detected.
 - **IP Conflicted:** If selected, trigger action if an IP conflicted is detected.
 - **Illegal Login:** If selected, trigger action when illegal logins are detected.
 - **Video Signal Exception:** if selected, trigger action when video signal is abnormal.
 - **Input/Output Video Standard Mismatch:** If selected, trigger action when video output standard does not match.
 - **Record/Capture Exception:** If selected, trigger action when record/capture exception is detected.
 - **Hot Spare Exception:** If selected, trigger action when Hot Spare Exception is detected.
 - **All:** if selected, trigger action when any one of exception above is detected.
3. Select the Actions to take when the exception is detected. More than one action can be selected. The actions available includes:
 - **Audible Warning:** DVR will sound an audio warning if exception is detected.
 - **Notify Surveillance Center:** DVR will notify surveillance center if exception is detected.
 - **Send Email:** DVR will send an email out to the designated recipients if exception is detected.

- **Trigger Alarm Output:** DVR will trigger alarm output if exception is detected. Selecting this option will enable the Alarm Output list, where the output to trigger can be selected.
4. Select the Apply button to save the exception settings and select  to return to the previous menu. Selecting  without clicking Apply will quit out of the menu without saving settings.

Configuring E-mail Settings

If you would like to have the DVR send out e-mails when certain events are detected or exceptions have been triggered, you must first setup the e-mail settings.





To setup e-mail settings:

1. Enter the Email Configuration menu by going to Menu > System Configuration > Network.
2. Select the Email tab, as shown in **Figure 141**.



Figure 141 Email Configuration Menu

3. In this tab, enter all pertinent email information, including:
 - **Enable Server Authentication:** Enable if email server requires authentication. Enabling Server Authenticating will enable the User Name and Password fields.
 - **User Name:** User name to use for server authentication.
 - **Password:** Password to use for server authentication.
 - **SMTP Server:** Address for SMTP server.
 - **SMTP Port:** Port for SMTP server.
 - **Enable SSL:** Enable Secure Sockets Layer (SSL) for out-going e-mail.

- **Sender Name:** The sender name to use when an e-mail is sent out from the DVR.
 - **Sender's Address:** The sender's address to use when an e-mail is sent out from the DVR.
 - **Enable Attached Picture:** Enabling will attach a small picture segment (Interval can be set below the Enable Attached Picture checkbox) to the out-going e-mail.
 - **Receiver:** Click  to edit Receiver Settings. Input the receiver's name and address. Click Apply to save the settings. The e-mail address  will be added to the Recipients list. You can also delete the receiver by clicking .
 - **Enable Email Interval:** Enable if need sending email between time intervals. The time interval can be set 1, 3, 5,10 minutes.
4. You may now test the e-mail settings by clicking the Test button.
 5. Select the Apply button to save the e-mail settings and select  to return to the previous menu. Selecting  without clicking Save will quit out of the menu without saving settings.

Configuring Hot Spare Settings

If there are a group of DVRs working in the same net, we can use the hot spare function to increase the reliability of the whole system.

To setup hot spare settings:

1. Enter the Hot Spare Configuration menu by going to Menu > System Configuration > Hot Spare (as shown in **Figure 142**).

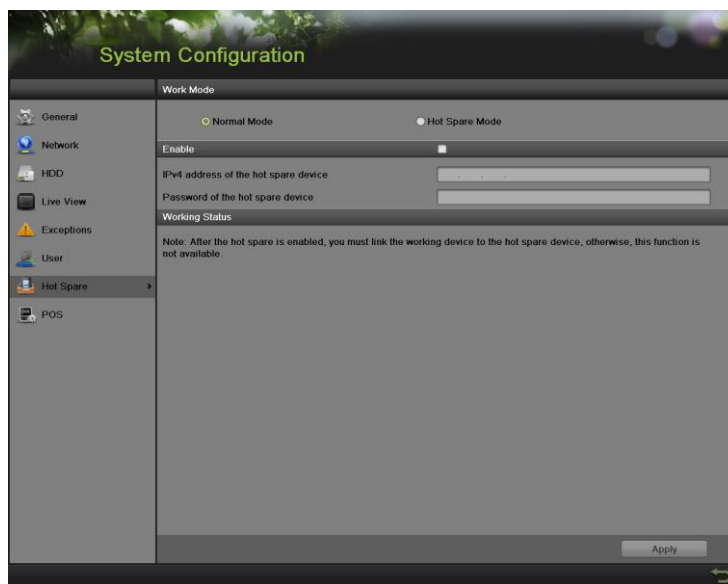



Figure 142 Hot Spare Configuration Menu

2. Choose the work mode of current DVR. Normal Mode indicates this DVR work as usual way. Hot Spare Mode means this DVR work as a hot spare device.

3. Once selected the normal mode, enter all the information required in the Enable tab, including: IPv4 address of the hot spare device, and the Password of the hot spare device.
4. Select the Apply button to save the e-mail settings and select  to return to the previous menu. Selecting  without clicking Save will quit out of the menu without saving settings.

Note: NVR and H-DVR support this function.

Configuring POS (Point of Sale) Settings

The POS feature supports display POS information on corresponding channels in preview and playback.

To setup POS settings:

1. Enter the POS configuration menu by going to Menu > System Configuration > POS.

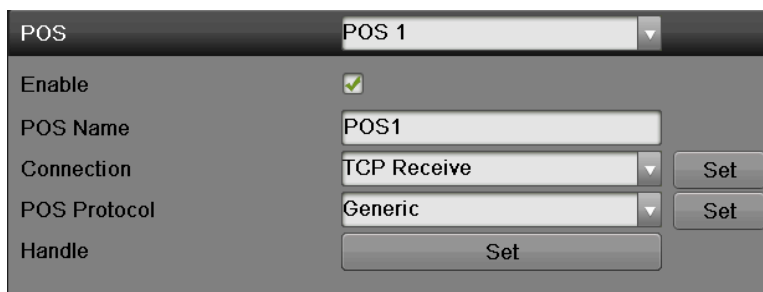

POS		POS 1
Enable	<input checked="" type="checkbox"/>	
POS Name	<input type="text" value="POS1"/>	
Connection	<input type="text" value="TCP Receive"/>	<input type="button" value="Set"/>
POS Protocol	<input type="text" value="Generic"/>	<input type="button" value="Set"/>
Handle	<input type="button" value="Set"/>	

Figure 143 POS configuration

2. Choose the POS channel for parameters setting.
3. Click on the Enable check box, and configure Device Name, Connection and POS Protocol.
4. Click Connection to select one connection mode between the Text In device and DVR.

Note: For the communication protocol AVE, it only supports RS-232 connection mode.

Note: For the communication protocol Generic, it supports all of the 3 connection modes above. (RS-232, TCP Listen and TCP Receive modes)

- a. For the RS-232 connection, click **Set** to configure RS-232 settings as follows.

Note: All the RS-232 settings should be consistent with the POS terminals settings, and the RS232 Mode shall be selected as Transparent Channel.

Note: Only 1 POS terminal can be connected via RS232.



Figure 144 RS232 Setting

b. For the **TCP Listen** mode, Click **Set** to enter TCP Listen Settings as follows.

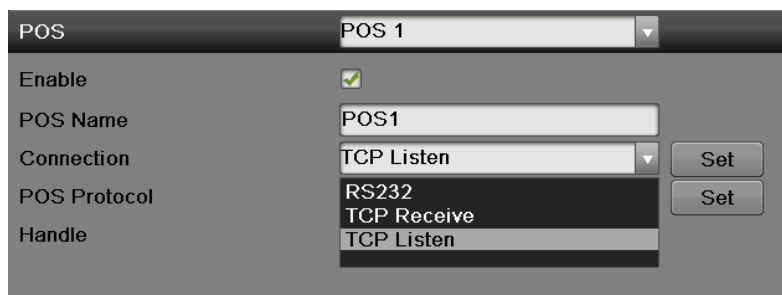

Figure 145 TCP Setting

Note: The IP Address should be exactly the same as the IP Address of POS terminal.
For this kind of connection, you should use a hub between the POS terminal and DVR.

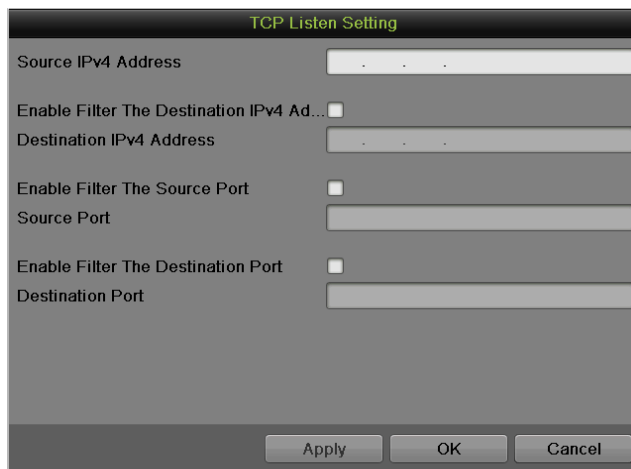

Figure 146 TCP listening

c. For the **TCP Receive** mode, Click Set to Network Receive Settings as follows.

Note: The port should be exactly the same as the port of POS terminal; you can click and edit it via virtual keyboard (The default port number is 10000).

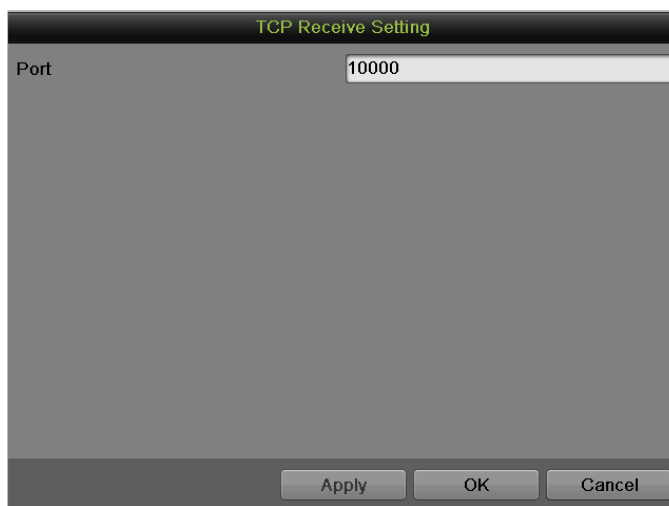
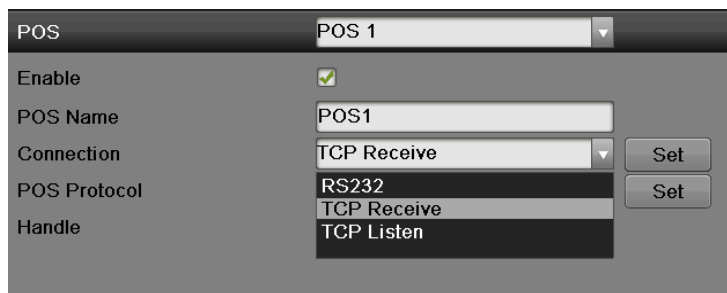

Figure 147 TCP Receive mode

5. Click **POS Protocol** to select one communication protocol between the POS terminal and DVR.

Note: For the communication protocol AVE, it only supports RS-232 connection mode.

Note: For the communication protocol Generic, it supports RS-232, TCP Listen and TCP Receive connection modes.

e. For the Generic protocol, click **Set** to configure Generic Settings as follows.

1) **Start Line Identifier:** You can define the transaction start string. The transaction data will start to display on the video and be recognized as the start of a new transaction every time when the DVR detects this Start Line Identifier string.

Note: Hex stands for Hexadecimal, which is a numeral system based on 16 common symbols 0–9 and A–F (or a–f). Click Hex check box to enable Hexadecimal mode.

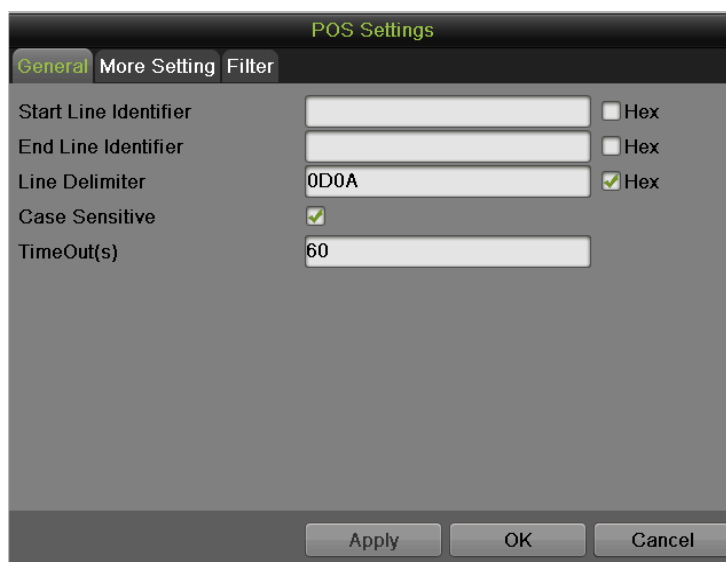

Figure 148 POS Setting

2) **End Line Identifier:** You can edit the End Line Identifier string when the transaction data should be finished to display on the video.

Note: Hex stands for Hexadecimal, which is a numeral system based on 16 common symbols 0–9 and A–F (or a–f). Click Hex check box to enable Hexadecimal mode.

3) **Line Delimiter:** Click to edit the line delimiter character via virtual keyboard as follows.

Note: Up to 40 characters can be displayed on each line, and the exceeding content will be automatically displayed at the next line.

Note: Hex stands for Hexadecimal, which is a numeral system based on 16 common symbols 0–9 and A–F (or a–f). Click Hex check box to enable Hexadecimal mode.

4) **Case Sensitive:** Click check box to differentiate between capital and lowercase letters.

- 5) **Timeout:** Click to set the Timeout period. When a message is delivered in abnormal status and can't be ended, the message will be forced to terminate over the timeout period. The default timeout period is 60s.
- 6) **Extra Line(s):** Click to select extra lines (from 0 to 10 lines) to be displayed on the video after detecting of End Line Identifier string. This option is designed for transaction data which ends with dynamic information (such as transactional time, etc) which could not be set as End Line Identifier string yet is still required to be displayed.



Figure 149 POS Setting

- 7) **Ignore Line:** Click to select how many strings of transactional data shall be ignored to display on the video (Maximum is four). And then click lower blank to edit the ignore character through the virtual keyboard as follows.
- 8) **Filter:** Filter helps to categories different POS events you are interested.



Figure 150 POS Setting

Every POS events will be filtered according to the **Descriptions** listed in the above interface, and then be labeled by the **filter Names**. Click **Add** to add filters. There are three kinds of filter modes.



The image shows a 'Filter Setting' dialog box with a dark header and two tabs: 'General' (selected) and 'More'. The 'Name' field contains 'Filter 4'. The 'Mode' dropdown menu is set to 'Key'. The 'Key' field is empty. At the bottom, there are three buttons: 'Apply', 'OK', and 'Cancel'.

Key Mode



The image shows a 'Filter Setting' dialog box with a dark header and two tabs: 'General' (selected) and 'More'. The 'Name' field contains 'Filter 4'. The 'Mode' dropdown menu is set to 'String'. The 'Key' field is empty. The 'Line' field contains '0'. The 'Column' field contains '1'. The 'String' field is empty. At the bottom, there are three buttons: 'Apply', 'OK', and 'Cancel'.

String Mode



Value Mode

Once selected the filter, click Up and Down to move the filter up and down in the list. The upper the filter, the higher the priority this filter has. If a POS event matches some filters, it will be labeled by the filter name which is listed on the top.

Note: In More tab, check the box 'Trigger Email' enable DVR to send a notifying email to designated email address, when a POS event matching this filter happens.

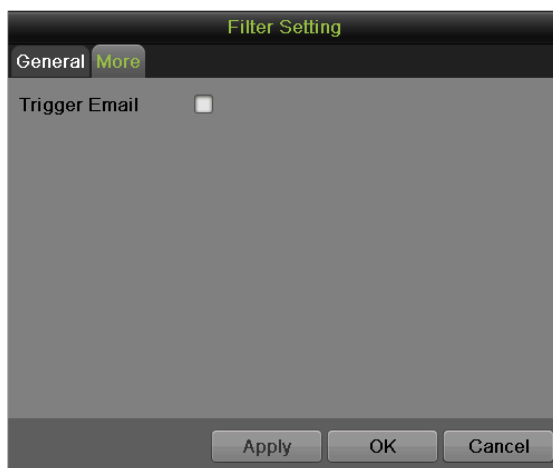

Figure 151 Filter Setting

- f. For the AVE protocol, click Set to configure AVE settings as follows.
 - 1) **Protocol:** Click to select the AVE protocol from the drop-down list.
 - 2) **Address:** The Address should be exactly the same as the Address of POS terminals
 - 3) **Timeout:** Click to set the Timeout period. Click to set the Timeout period. When a message is delivered in abnormal status and can't be ended, the message will be forced to terminate over the timeout period.

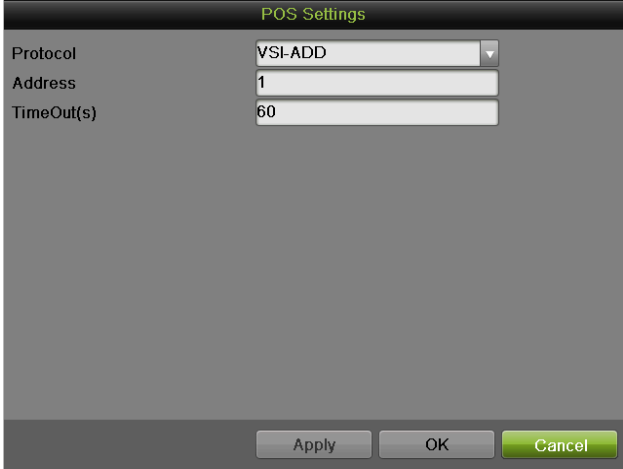

Figure 152 POS Setting

CHAPTER 9 Camera Management

Configuring Cameras

Adding and Removing IP Cameras

Depending on the model of your DVR, IP cameras can be setup and used in conjunction with regular analog cameras.

Before configuring IP cameras, please ensure the network settings for your DVR is properly setup.

To manage IP cameras:

1. Enter the Cameras menu by going to Menu > Cameras Setup > Cameras.
2. Select the IP Camera tab, as shown in **Figure 153**.



Figure 153 IP Camera Configuration Menu

3. Click the Refresh button to automatically detect connected IP cameras on the network.
4. Check the checkbox of certain detected cameras to add. The basic information of the selected camera will display on the left side of the interface.
5. If the password of the selected IP camera is default, you can click Quick Add to add the camera. Otherwise enter the password in the Camera Password box on the left side.
You can also edit the basic parameters of the selected camera by click [✎] before you add it or directly edit it on the left side of the interface.
6. Click the Upgrade button to upgrade the firmware of added IP cameras in local menu .
7. Click Protocol to pop up a Protocol Management box, as shown in **Figure 154**, to edit the protocol parameters.

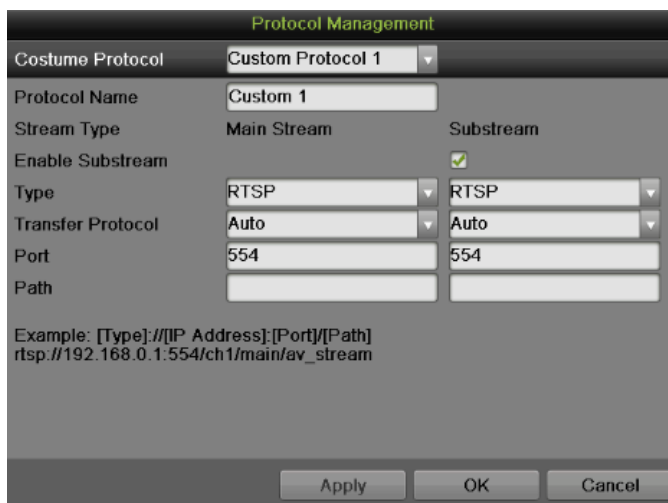

Figure 154 Protocol Management Settings Menu

8. If the IP camera is not online, you can enter the IP address, protocol, configuration port, camera user name and other information on the left side of the interface.
9. Click Add to add this camera.

You can also use the right-click menu during live view to quickly add IP cameras.

To quickly add IP cameras:

1. Enter the live view menu and right click the mouse, as shown **Figure 155**, in then choose the Add IP camera option.

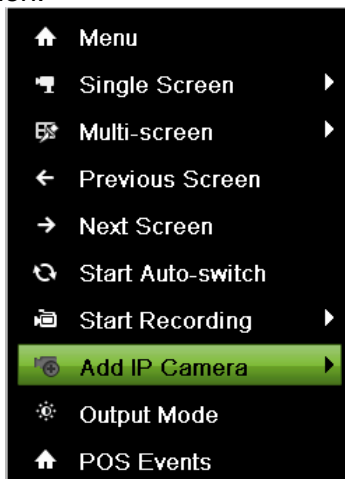

Figure 155 Right-Click Menu

2. Click Auto to automatically detect and add IP cameras. Or click Manual to manually manage the IP cameras, as shown in **Figure 156**.

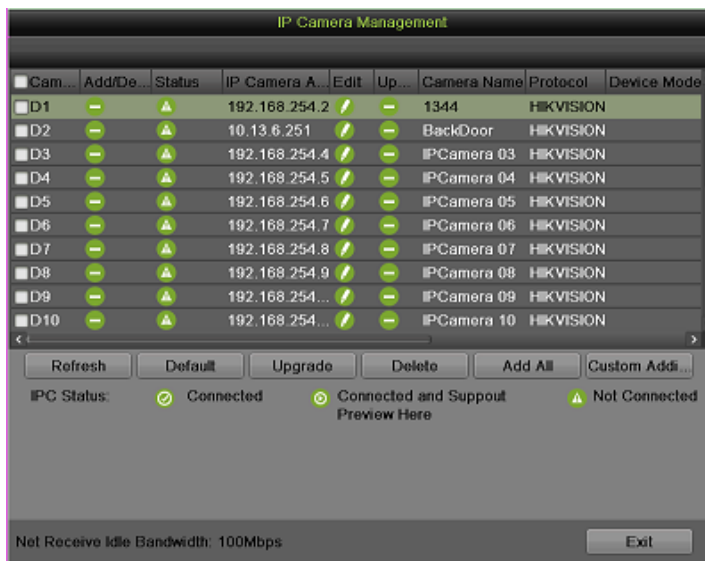



Figure 156 IP Camera Management Menu

The added cameras will display in a list. You can also configure the added camera. To configure added camera:

1. Click  in the added camera list to pop up an Edit IP Camera menu, as shown in **Figure 157**.

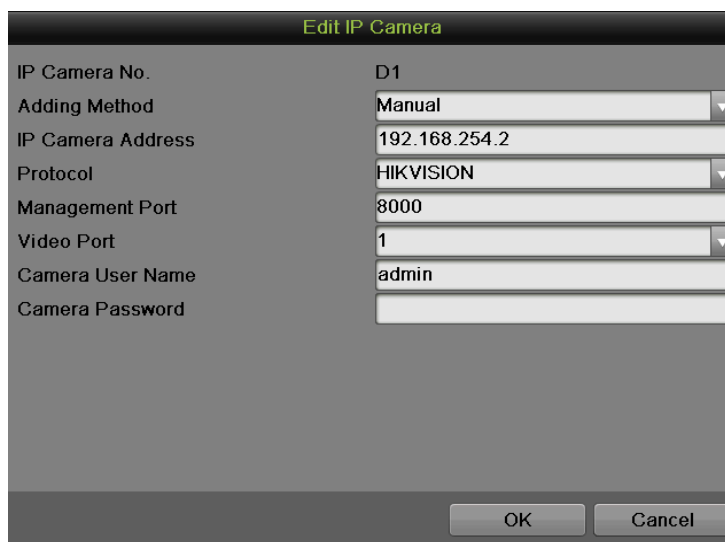



Figure 157 Edit IP Camera

2. You can edit the IP Camera Address, Protocol, Configuration Port and Video Port.
3. Click the Apply button to save the settings. Click OK to exit this menu. Click Cancel without click Apply or OK will back without saving.
4. For editing more parameters, click the Advance Set button to pop up an Advance Settings window, as shown in **Figure 158**.



Figure 158 Advance Settings Menu

5. Select the Network tab to modify the IP Camera Address and Configuration Port. Click Apply to save the settings.
6. Select Password tab to change the password. Click Apply to save the settings.
7. Click OK to exit this menu.
8. Click  to delete camera.
9. Click  to get the live view of the camera.

Note:

Support third party IP camera: PANASONIC, SONY, AXIS, SANYO, BOSCH, and ACTI.

Adding and Removing Analog Cameras

Analog cameras can be enabled and disabled in the Cameras menu.

To manage analog cameras:

1. Enter the Cameras menu by going to Menu > Cameras Setup > Cameras.
2. Select the Analog tab, as shown in **Figure 159**.



Figure 159 Analog Camera Settings Menu

3. To enable a camera, check the box of the corresponding camera number. To disable a camera, uncheck the box. You may also check and uncheck Analog to enable and disable all cameras.
4. Select the Apply button to save the camera settings. There will pop up an Attention message box, as shown in **Figure 160**.



Figure 160 Enable/Disable Analog Camera Attention Message

5. Click Yes to reboot and make the settings effective. Click No to cancel and back to the previous menu.

Note:

Enable or disable analog cameras function is only for 9000 series Hybrid DVR device.

IP cameras List Import and Export

The added IP camera list can be imported and exported in the Camera menu.

To export IP camera list:

1. Enter the Cameras menu by going to Menu > Cameras Setup > Cameras. Select the IP Camera Import/Export tab, as shown in **Figure 161**.

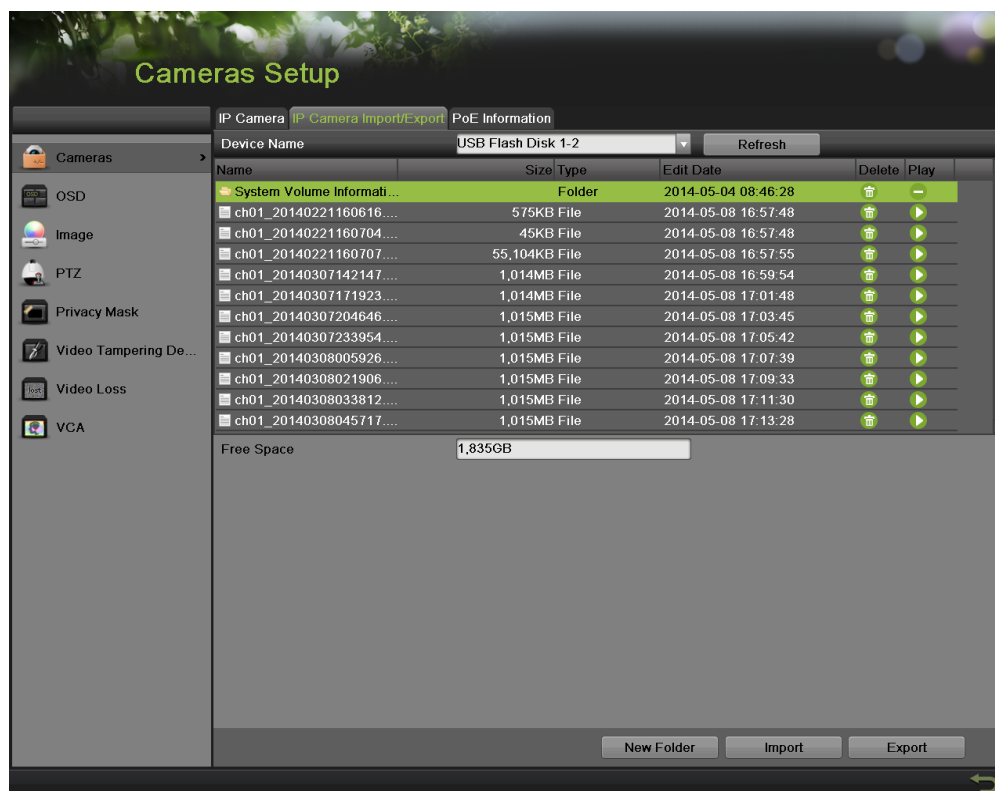



Figure 161 IP Camera Import/Export Management Menu

2. Connect the USB storage device to a USB port on the DVR.
3. Click the Refresh button. The contents of the USB storage device will be shown on the screen.
4. You can click the New Folder button to create a new folder.
5. Select the location where you would like the configuration to be stored on the USB storage device.
6. Click Export to export an IP camera list file to USB storage device.
7. Click  to exit out of the Import / Export menu.

To import IP camera list:

1. Enter the Cameras menu, shown in **Figure 161** by going to Menu > Cameras Setup > Cameras. Select the IP Camera Import/Export tab, as shown in **Figure 161**.
2. Connect the USB storage device to a USB port on the DVR.
3. Click the Refresh button. The contents of the USB storage device will be shown on the screen.

4. Select the list file.
5. Click the Import button.
6. In the pop-up window click Yes to confirm the import and the system will automatically reboot to make it effective
7. Click  to exit out of the Import/Export menu.

PoE Information

Detailed PoE power consumption information and configuration can be accessed in this tab.

To access the PoE information:

1. Enter the Cameras menu by going to Menu > Cameras Setup > Cameras. Select the PoE Information tab, as shown in **Figure 162**.

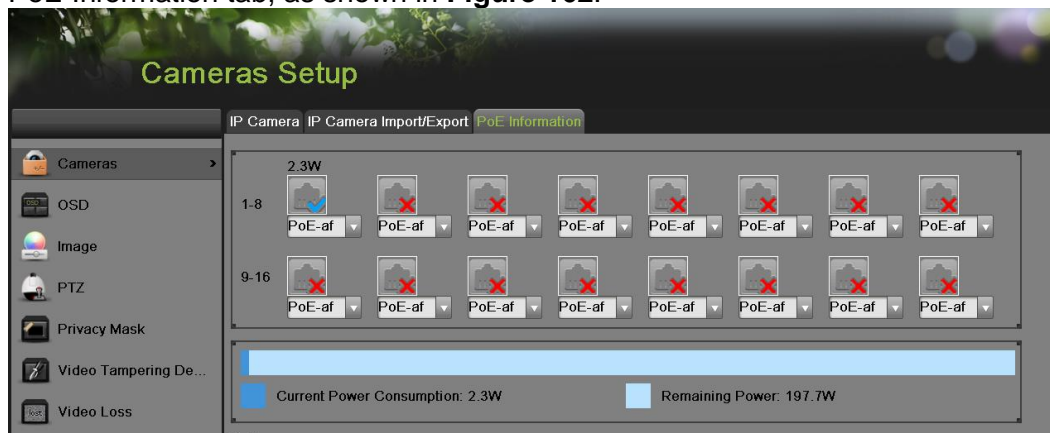



Figure 162 PoE Information interface

2. Choose the corresponding IPC channel and choose the suitable PoE protocol: PoE-af, PoE-at, and no PoE.
3. Click Apply button.
4. Click  to exit out of the PoE Information menu.

Note:

This function is only available on specified 7716NI-SP model.



Configuring Privacy Mask

Privacy Mask can be setup to mask off sensitive or private areas in the field of view of a camera. To configure privacy zones:

1. Enter the Privacy Mask menu, shown in **Figure 163** by going to Menu > Cameras Setup > Privacy Mask.



Figure 163 Privacy Mask Settings Menu

2. Select the camera to setup privacy mask in using the camera dropdown list on the upper left of the menu.
3. Check the Enable Privacy Mask checkbox to enable privacy mask.
4. Up to four privacy masks can be used per camera and are shown using four different colors, yellow, green, blue and grey. Using the mouse, click and drag out rectangular boxes defining the desired zones.
5. You may clear a privacy zone at any time by clicking on the corresponding Clear Zone button or Clear All button to clear all zones.
6. If the same settings can be applied to other channels, click Copy.
7. Select the Apply button to save the privacy mask settings and select  to return to the previous menu. Selecting  without clicking Apply will quit out of the menu without saving settings.

Configuring Tamper-proof

Tamper-proof detection can be used to recognize if an area of a camera is purposely covered and to respond accordingly.

To configure tamper-proof detection:

1. Enter the Tamper-proof menu, shown in **Figure 164** by going to Menu > Cameras Setup > Tamper-proof.

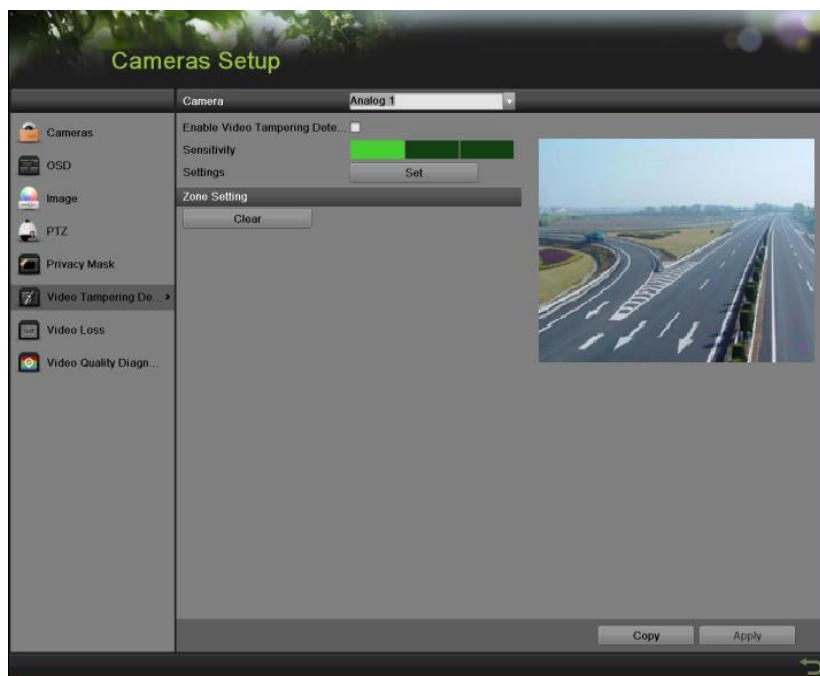

Figure 164 Video Tamper-proof Detection Menu

2. Select the camera to setup video tampering detection in using the camera dropdown list.
3. Check the Enable Tamper-proof checkbox.
4. Adjust the Sensitivity for video tampering detection.
5. Using the mouse, select the region on the preview screen for where you would like to enable tamper-proof on. Press the Clear button to clear region.
6. Press the Handling Set button to set up handling method.
 - 1) Select the Arming Schedule tab to set the arming schedule. Up to 8 periods can be configured. If the same schedule can be applied in other days, click Copy.
 - 2) Select the Handling tab to set the actions to take if tamper-proof is detected.
 - 3) Click Apply to save the settings. Click OK to back to the previous menu.
7. If the same settings can be applied in other channels, click Copy to copy the same configuration to other channels.
8. Click Apply to save the settings.

Configuring Video Loss

Video loss detection can be enabled on any of the channels on your DVR to detect the loss of video.

To configure video loss detection:

1. Enter the Video Loss menu, shown in **Figure 165** by going to Menu > Cameras Setup > Video Loss.



Figure 165 Video Loss Detection Menu

2. Select the camera to setup video loss detection in using the camera dropdown list.
3. Click Enable Video Loss Detection.
4. Press the Handing Set button to set up handing method.
 - 1) Select the Arming Schedule tab to set the arming schedule. Up to 8 periods can be configured. If the same schedule can be applied in other channel, click Copy.
 - 2) Select the Handing tab to set the actions to take if video loss is detected.
5. Click the Apply button to save the settings. Click OK to back to the previous menu.
6. If the same settings can be applied in other channels, click Copy to copy the same configuration to other channels.
7. Click Apply to save the settings.

Configuring OSD Settings



On Screen Display (OSD) settings can be configured in the OSD menu. The OSD is shown in each display in Live Feed and Playback mode.

To configure OSD settings:

1. Enter the OSD menu, shown in **Figure 166** by going to Menu > Cameras Setup > OSD.



Figure 166 OSD Configuration Menu

2. Select the camera to setup OSD configuration in using the camera dropdown list.
3. Configure OSD settings, including:
 - **Camera Name:** Name of selected camera.
 - **Display Name:** Enable to display camera name in OSD.
 - **Display Date:** Enable to display date in OSD.
 - **Date Format:** Format of date.
 - **Time Format:** Format of time.
 - **Display Mode:** Display style for OSD.
4. Using the mouse, click and drag OSD elements on preview screen to desired location.
5. If the same configurations can be applied to other channels, click Copy to copy the settings to other channels.
6. Select the Apply button to save these settings and select  to return to the previous menu. Selecting  without clicking Apply will quit out of the menu without saving settings.

Configuring Video Quality Diagnosis



Video Quality Diagnosis settings can be enabled on any of the channels on your DVR to diagnose the change of video quality. If the video quality turns bad to a certain extent, this function will alarm to users.

To configure video quality diagnosis settings:

1. Enter the video quality diagnosis menu, shown in **Figure 167** by going to Menu > Cameras Setup > video quality diagnosis.



Figure 167 Video Quality Diagnosis Configuration Menu

5. Select the camera to setup Video Quality Diagnosis configuration in using the camera dropdown list.
6. Check the Enable Video Quality Diagnosis check box to enable this function.
7. Click the Handling button to set the alarming schedule and linkage action.
8. Configure Diagnosis Mode settings, including:
 - **Blurred Image:** the blurredness of image.
 - **Abnormal Brightness:** the brightness of the image.
 - **Color Cast:** the color cast of image.
9. If you want to reset the default settings of threshold, click Default to set a default threshold value to each kind of diagnosis mode.
10. If the same configurations can be applied to other channels, click Copy to copy the settings to other channels.
11. Select the Apply button to save these settings and select  to return to the previous menu. Selecting  without clicking Apply will quit out of the menu without saving settings.

Configuring VCA

VCA settings can be enabled on any of the channels on your DVR to detect VCA events. If the VCA related events happen, this function will alarm to users.

Note: this function can be only enabled by VCA-supported cameras.

To configure VCA settings:

1. Enter the Video Loss menu, shown in **Figure 168** by going to Menu > Cameras Setup > VCA.



Figure 168 VCA Menu

12. Select the camera to setup VCA in using the camera dropdown list.
13. Click Enable VCA.
14. Press the Handing Set button to set up handing method.
 - 3) Select the Arming Schedule tab to set the arming schedule. Up to 8 periods can be configured. If the same schedule can be applied in other channel, click Copy.
 - 4) Select the Handing tab to set the actions to take if VCA event is detected.
15. Click the Apply button to save the settings. Click OK to back to the previous menu.
16. If the same settings can be applied in other channels, click Copy to copy the same configuration to other channels.
17. Click Apply to save the settings.

CHAPTER 10

RAID Configuration

Configuring Array and Virtual Disk

RAID (redundant array of independent disks) is a storage technology that combines multiple disk drive components into a logical unit. A RAID setup stores data over multiple hard disk drives to provide enough redundancy so that data can be recovered if one disk fails. The DS-9000HFI-RT/9600NI-RT/9600NI-ST/9600NI-XT are capable of realizing RAID settings, supporting RAID 0, RAID 1, RAID 5 and RAID 10.

The DS-9000HFI-RT/9600NI-RT/9600NI-ST/9600NI-XT series can store the data (such as record, picture, log information) in the HDD only after you have created the virtual disk or you have configured network HDD (refer to Setting Network HDD). Our device provides two ways for creating the virtual disk, including one-touch configuration and manual configuration. The following flow chart shows the process of creating virtual disk.

Note:

Please install the HDD(s) properly and it is recommended to use the same enterprise-level HDDs (including model and capacity) for array creation and configuration so as to maintain reliable and stable running of the disks.

One-touch Configuration

You can quickly create the disk array and virtual disk through one-touch configuration. By default, the array type to be created is RAID 5.

Steps:

1. Enter the Physical Disk interface by going to Menu > System Configuration > RAID > Physical Disk, as shown in **Figure 169**.

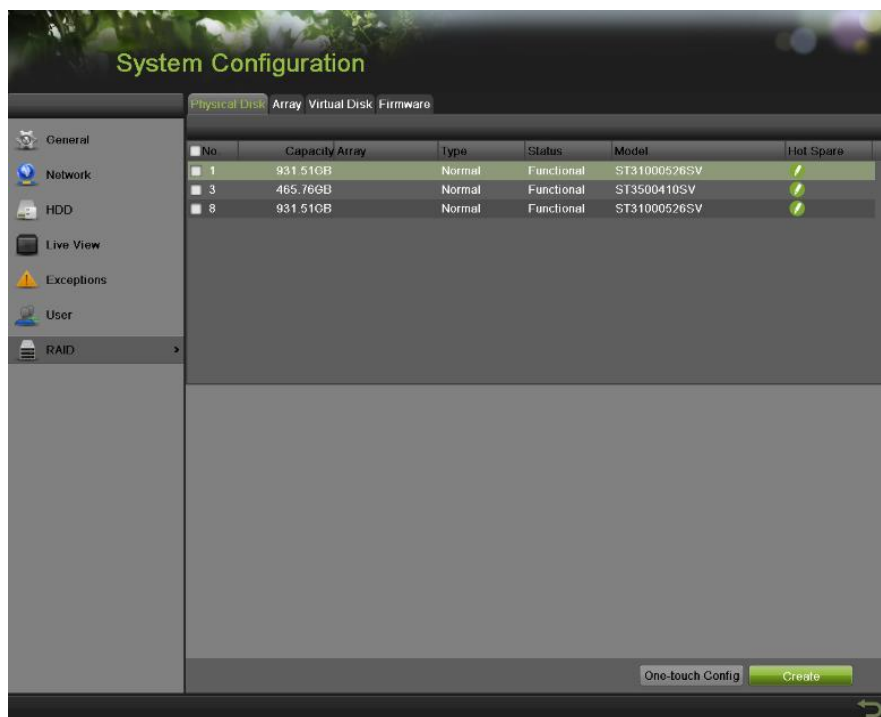

Figure 169 Physical Disk Settings Menu

2. Click the One-touch Config button to pop-up a One-touch Array Configuration box as shown below.

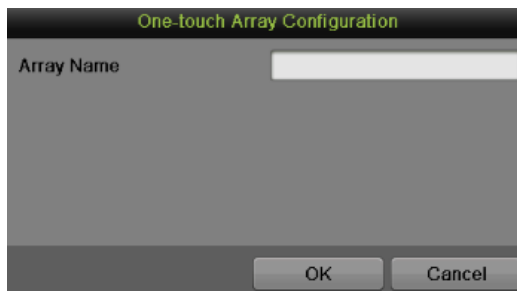

Figure 170 One-touch Array Configuration

3. Edit the array name in the Array Name text box and click OK to start configuration the array.
4. There will pop-up an Attention box when the array configuration is completed. Click OK to finish the settings.
5. You can select the Array tab to view the information of the successfully created array.
6. You can select the Virtual Disk tab to view the information of the created virtual disk.

Note:

As the default array is RAID 5, at least 3 HDDs must be installed.

If you install 4 HDDs or above for one-touch configuration, a hot spare disk will be set as default.

Note:

By default, one-touch configuration creates one array and one virtual disk. If the capacity of the array created by one-touch configuration is larger than 16TB, two arrays and two virtual disks will be created.

Note:

By default, one-touch configuration adopts foreground initialization to initialize the virtual disk. By using foreground initialization, the virtual disk can be used only after the initialization is complete.

Manually Creating Array and Virtual Disk

You can manually create the array of RAID 0, RAID 1, RAID 5, RAID 10. We take RAID 5 as an example. To create the array of RAID 5:

Steps:

1. Enter the Physical Disk interface by going to Menu > System Configuration > RAID > Physical Disk, as shown in **Figure 169**.
2. Click the Create button to enter the Create Array menu, as shown below.

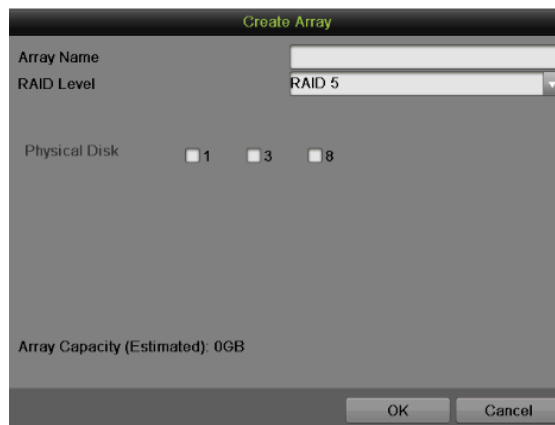

Figure 171 Create Array Interface

3. Edit the Array Name.
4. Select the RAID Level from RAID 0, RAID 1, RAID 5 and RAID 10.
5. Check the checkbox of corresponding disk to select the Physical Disk that you want to configure array.
6. Click OK to create array.
7. Click Array tab to view the successfully created array.
8. Click to select an array and click Create Vd to enter the Create Virtual Disk interface.

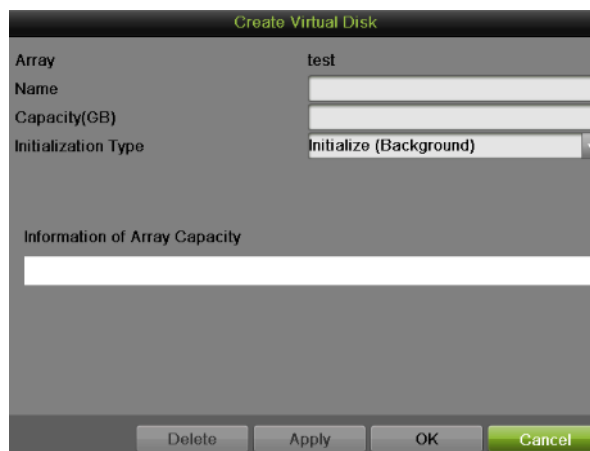

Figure 172 Create Virtual Disk Interface

9. Edit the Virtual Disk Name.
10. Set the Capacity of the virtual disk. And at least 100 GB capacity must be configured for each virtual disk. You can click the Information of Array Capacity area to set the remaining capacity of the array for the disk.
11. Select the Initialization Type from Background, Foreground and Fast.
 - **Background:** The background initialization can synchronize the disks, and detect and repair the bad sector of the disks. During the background initialization, the virtual disk is allowed to be used.

- **Foreground (Recommended):** By using foreground initialization, the RAID will be initialized totally and the bad sector of the hard disks can be detected and repaired. The virtual disk can be used only after the initialization is complete.
 - **Fast:** The fast initialization usually takes short time and only initializes part of the RAID, and cannot detect the bad sector.
12. Click the Apply button to save the settings and click OK to return to the Array interface.
 13. Click Virtual Disk tab to enter the virtual disk interface. The successfully created virtual disk will be listed on the interface.
 14. Enter the HDD Information interface and the virtual disk will display. For operation guide of initializing the virtual disk, please refer to Page 116 if you adopt foreground initialization, the virtual disk will display in the HDD Information interface after the initialization is complete.

Label	Capacity	Status	Property	Type	Free Space	Group	Edit	Delete
1	931GB	Uninitialized	R/W	Array	0MB	1	-	-

Figure 173 HDD Information Interface

15. After the virtual disk has been initialized, the status will change from Uninitialized to Normal.
16. Enter the Physical Disk interface to configure the hot spare disk if you have installed the fourth disk.

No.	Capacity Array	Type	Status	Model	Hot Spare
1	931.51GB test	Array	Functional	ST31000526SV	-
3	465.76GB test	Array	Functional	ST3500410SV	-
7	931.51GB	Normal	Functional	WDC WD10EUVS-63M5B0	!
8	931.51GB test	Array	Functional	ST31000526SV	-

Figure 174 Physical Disk Interface

17. Select the disk and click  to enter the Set Hot Spare interface.



Figure 175 Set Hot Spare Interface

18. Set the Hot Spare Type of the selected HDD to Global Hot Spare or the specified hot spare for the existing array.
19. **Global Hot Spare:** It can be used as the hot spare for any array created in the system.
20. **Specified Hot Spare (e.g. test):** It can be used as the hot spare for the specified array only.
21. Click OK to finish the settings.

Note:

When the auto-rebuild function is enabled, the hot spare disk will be automatically used for array rebuilding if the virtual disk is in Degraded status.

Note:

At least 2 HDDs must be installed for RAID 0.
2 HDDs needs to be configured for RAID 1.
At least 3 HDDs must be installed for RAID 5.
4/6/8 HDDs need to be cofigured for RAID 10.

Note:

A physical disk count error attention box will pop-up, if the number of HDDs you select is not compatible with the requirement of the RAID level.

Note:

The device supports creating at most 8 virtual disks.

Note:

It is recommeded to create one virtual disk of an array.

Rebuilding Array

The working status of array includes Functional, Degraded and Offline. When there is no disk loss in the array, the working status of array will change to Functional; when the number of lost disks has exceeded the limit, the working status of array will change to Offline; in other conditions, the working status is Degraded. When the virtual disk is in Degraded status, you can restore it to Functional by array rebuilding.

Automatically Rebuilding Array

Enable Auto-rebuild can start rebuilding the array automatically with the hot spare disk when the virtual disk is in Degraded status to ensure the high security and reliability of the data. To set auto-rebuild:

1. Enter the Firmware interface by going to Menu > System Configuration > RAID > Firmware, as shown in **Figure 176**.

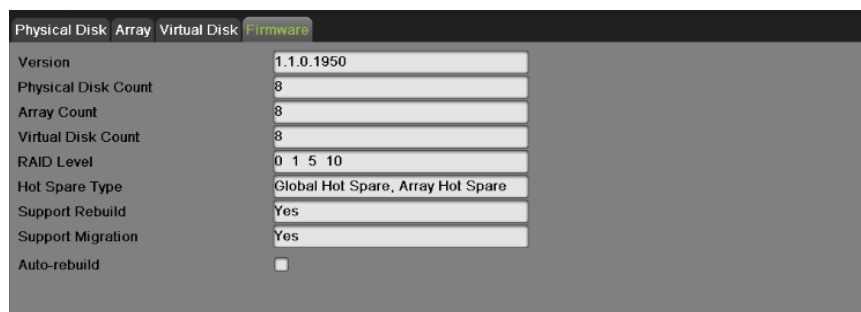

Figure 176 Firmware Interface

2. Check the Auto-rebuild box to enable auto-rebuild.
Since the hot spare disk is configured and Auto-rebuild function is enabled. The hot spare disk will be automatically used for array rebuilding when the status of the array is Disk Loss. You can check the rebuild status by going to Menu > System Configuration > RAID.

1. Select Array tab to view the array rebuilding status.

Physical Disk	Array	Virtual Disk	Firmware						
No.	Name	Free S...	Physical...	Status	Level	Rebuild	Migrate	Delete	Task
1	test	0/931G	1 7 8	Disk Loss	RAID 5				Rebuild(Running)

Figure 177 Array Interface

2. Select Virtual Disk tab to view the virtual disk rebuilding status.

Physical Disk	Array	Virtual Disk	Firmware					
No.	Name	Capacity	Array	Status	Type	Repair	Delete	Task
1	2013	931G	test	Degraded	RAID 5			Rebuild(Running) 0%

Figure 178 Virtual Disk Interface

Note:

If there is no hot spare disk after rebuilding, it is recommended to install a HDD into the device and set it as a hot spare disk to ensure the high security and reliability of the array.

Manually Rebuilding Array

If you do not enable the Auto-rebuild in Firmware interface or the hot spare disk has not been configured, you can rebuild the array manually to restore the array when the virtual disk is in Degraded status. To manually rebuilding array:

1. Enter the Array interface by going to Menu > System Configuration > RAID > Array tab.
2. Click  to pop up the Rebuild Array box.

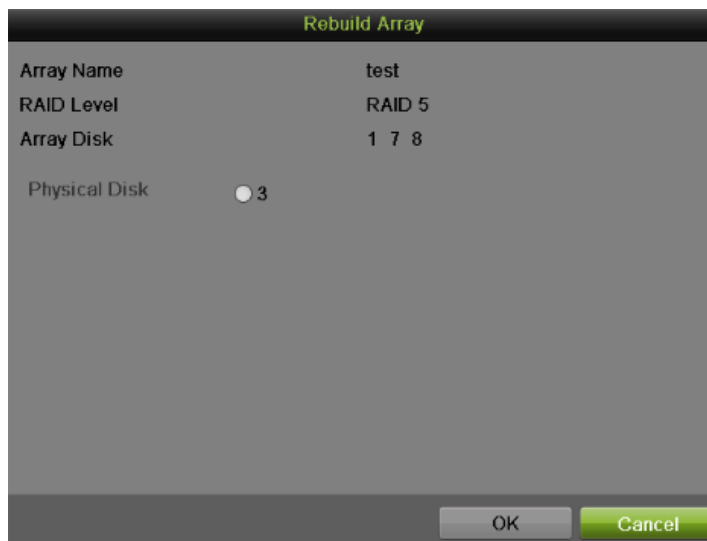

Figure 179 Rebuild Array Interface

3. Select the available physical disk and click OK to confirm to rebuild the array.
4. There will pop up an attention box with these words: Do not unplug the physical disk when it is under rebuilding. Click OK to start rebuilding.
5. You can enter the Array Settings interface and Virtual Disk interface to view the rebuilding status.
6. After rebuilding successfully, the array and virtual disk will restore to Functional.

Note:

At least one available physical disk should exist for rebuilding the array.

Note:

It is recommended to enable the Auto-rebuild function and set the hot spare disk for automatically rebuilding the array

Repairing Virtual Disk

When the disk cannot display in the HDD Information interface while the virtual disk can still show in the Array Settings interface, you have to repair the virtual disk.

Note:

If the virtual disk is under foreground initialization, the repairing cannot be done.

To repairing virtual disk:

1. Enter the Virtual Disk interface by going to Menu > System Configuration > RAID > Virtual Disk

Physical Disk Array Virtual Disk Firmware							
No.	Name	Capacity Array	Status	Type	Repair	Delete	Task
1	vd1	100G test	Degraded	RAID 5			None
2	vd2	100G test	Degraded	RAID 5			None

Figure 180 Virtual Disk Interface

- Click to repair the virtual disk.
- After successfully repairing, the following attention box will pop up. Click OK to finish the settings.

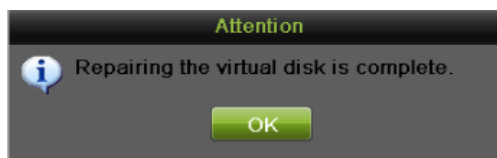

Figure 181 Repair Attention Message

- You can see the disk again in the HDD Information interface.

Deleting Array / Virtual Disk

You can delete the array and virtual disk. Before deleting the array, the virtual disk(s) under this array must be deleted first.

Deleting the Virtual Disk

To delete the virtual disk:

- Enter the Virtual Disk interface by going to Menu > System Configuration > RAID > Virtual Disk.
- Select a virtual disk and click to delete the virtual disk.



Figure 182 Attention Message

- Click the Yes button to confirm the virtual disk deletion.

Note:

Deleting virtual disk will cause to delete all the data saved in the disk.

Deleting the Array

If all the virtual disks under an array have been deleted, then you can delete that array. To delete the array:

- Enter the Array interface by going to Menu > System Configuration > RAID > Array.

2. Select an array and click  to delete the array.
3. In pop-up attention box, click the Yes button to confirm the array deletion.

Note:

Deleting array will cause to delete all the data in the array.

Migrating and Expanding

When the remaining storage space is lower than the actual needs, you can take array migration and online expansion to enlarge the capacity of the virtual disk. At least one available physical disk should exist for the array migration.

To migrating and expanding:

1. Enter the Physical Disk interface by going to Menu > System Configuration > RAID > Physical Disk to confirm at least one available physical disk has existed for the array migration.
2. Select Array tab to enter the Array interface.
3. Select the array to be migrated and click  to enter the Migrate Array interface.

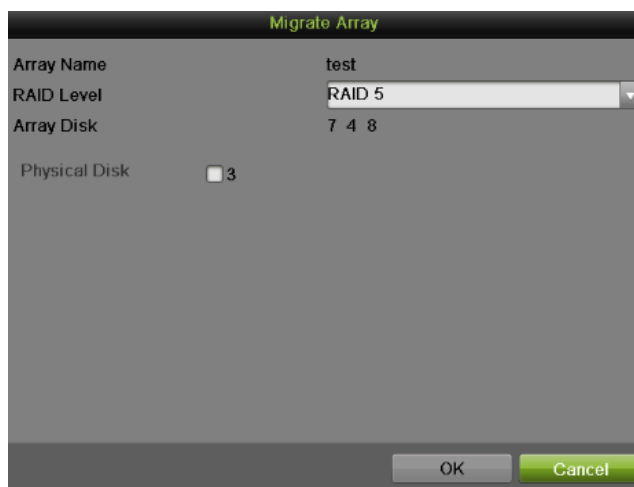

Figure 183 Migrate Array Interface

4. Select the available physical disk and click OK to confirm the settings.
5. There will pop up an attention box with these words: Do not unplug the physical disk when it is under rebuilding. Click OK to start rebuilding.
6. You can enter the Array interface and Virtual Disk interface to check the process of the migration.



Physical Disk Array Virtual Disk Firmware										
ID	Name	Free S...	Physical Disk	Hot Sp...	Status	Level	Rebuild	Migrate	Delete	Task
1	test	831/931G3	7 4 8		Functional	RAID 5				Migrate(Run...

Figure 184 Array Interface

Physical Disk Array Virtual Disk Firmware									
No.	Name	Capacity	Array	Status	Type	Repair	Delete	Task	
1	vd1	100G	test	Functional	RAID 5	—	🗑️	Migrate(Running) 1%	

Figure 185 Virtual Disk Interface

7. Reboot the device to take effect of the new setting after the migration process finished.
8. Enter the HDD Information interface after rebooting by going to Menu > System Configuration > HDD > HDD Information.
9. Select an expandable virtual disk and click the Expand button to expand the capacity of the virtual disk.

HDD Information Record Information Storage Mode									
<input type="checkbox"/>	Label	Capacity	Status	Property	Type	Free Space	Group	Edit	Delete
<input checked="" type="checkbox"/>	1	150GB	Normal/Expansion	R/W	Array	99GB	1	—	—
<input type="checkbox"/>	2	100.00GB	Normal	R/W	Array	99GB	1	—	—

Figure 186 HDD Information Interface

10. In the pop-up message box, click OK to start expanding.



Figure 187 Expand Warning Message

11. After expanding finished, the following message box will pop up. Click OK to finish the settings.

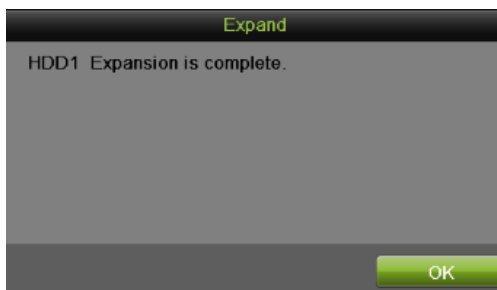

Figure 188 Expand Finish Message

Note:

Only migrating from RAID 5 to RAID 5 is supported by the device.
If there is no virtual disk existing under the array, the array migration cannot be done.
If the virtual disk of the array is under initialization, the array migration cannot be done.

Note:

After RAID migration and capacity expansion, the expanded capacity for each virtual disk can be calculated by the following formula: Expanded VD capacity = (Original VD Capacity / Original Array Capacity) * Newly Added Capacity of Hard Disk.

Upgrading Firmware

You can view the information of the firmware and upgrade the firmware by local backup device or remote FTP server.

1. Enter the Firmware interface to check the information of the firmware, including the version, maximum physical disk quantity, maximum array quantity, auto-rebuild status, etc.

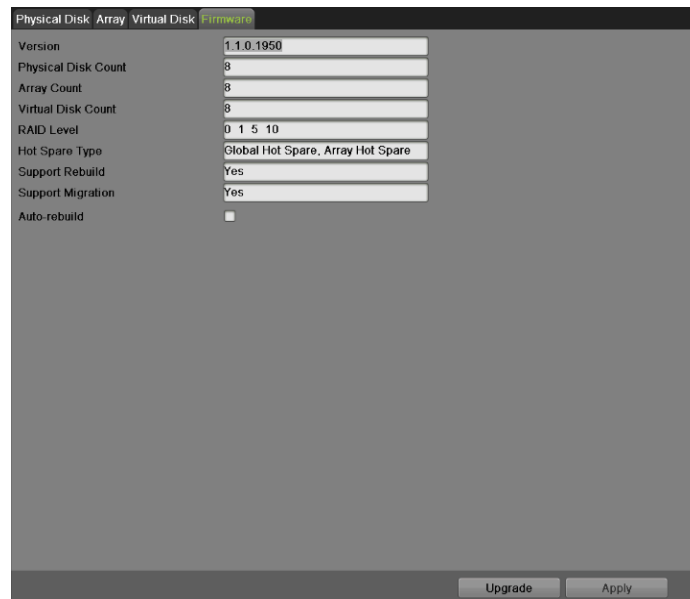

Figure 189 Firmware Interface

2. You can click the Upgrade button to upgrade the firmware. Local upgrade and FTP upgrade are available.

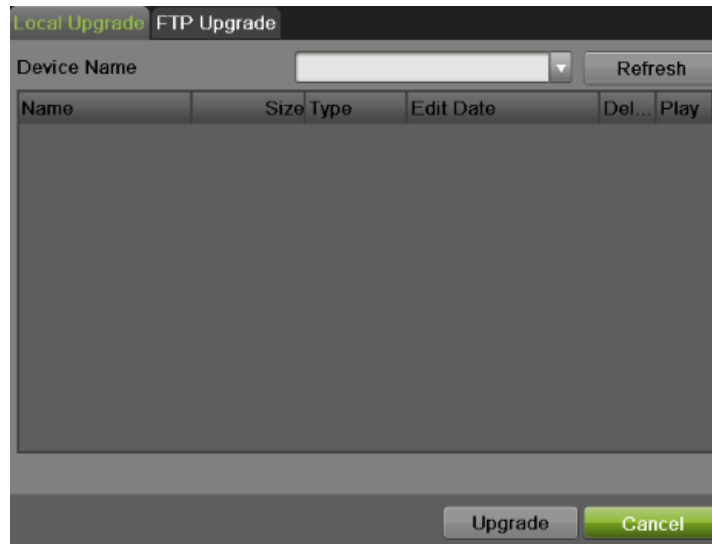

Figure 190 Upgrade Interface

CHAPTER 11 Disk Management

Managing Disks

Checking Disk Status

The status of all installed hard disk drives (HDD) and Network hard drives can be checked under the HDD menu.

To check the status of installed disks:

1. Enter the HDD menu, shown in **Figure 191** by going to Menu > System Configuration > HDD.

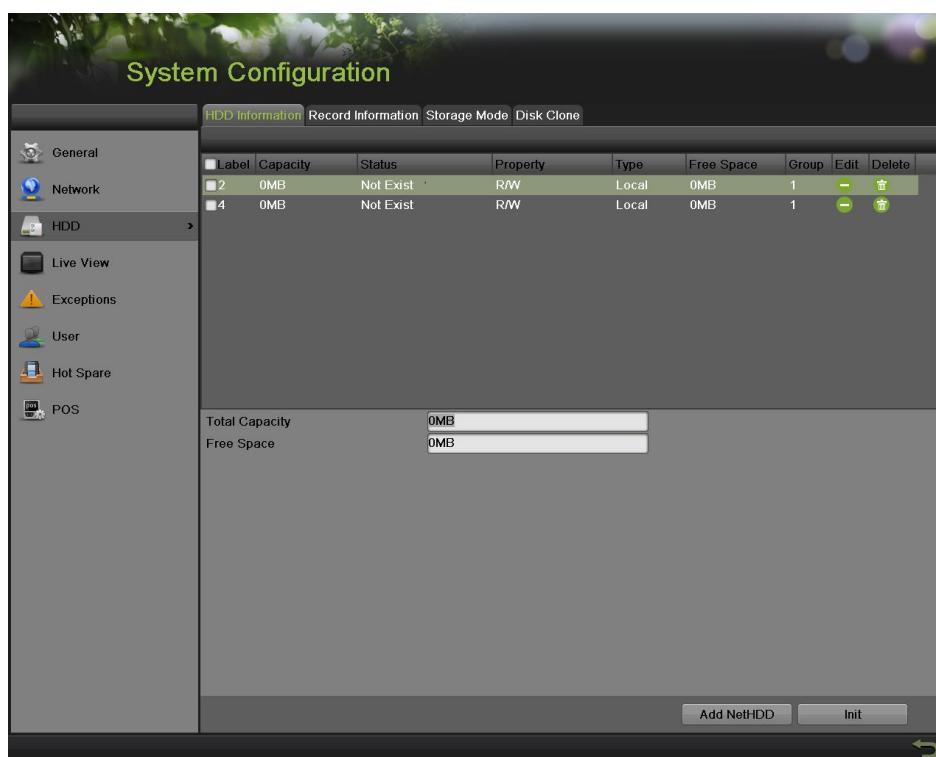

Figure 191 HDD Management Menu

2. Select the HDD Information tab to check the disk status, capacity, property, type and free space.

Setting Network HDD

Add the allocated DVR Storage Space of NAS or disk of IP SAN to DVR, this part will work as network HDD.

To set a network HDD:

1. Enter the HDD menu by going to Menu > System Configuration > HDD.
2. Click the Add NetHDD button to pop up the Add NetHDD menu, as shown in **Figure 192**.



Figure 192 Add NetHDD Menu

3. Select the number and the type of network hard drive. Then enter in the IP address and the directory of network hard drives.
4. If you do not know the directory of network hard drives, you can click Search after you enter the IP address. The network hard drives in this subnet will be listed below. Select the one you want to add.
5. Click OK to save the settings and return the pervious menu. The added hard drives will appear on the list of HDDs.
6. You can edit or delete the network hard drivers on the HDD Information menu.

Formatting Disk

A newly installed hard disk drive (HDD) must be first formatted before it can be used with your DVR. Formatting the disk will erase all data on it.

To format a new disk:

1. Enter the HDD menu by going to Menu > System Configuration > HDD.
2. Select a disk to format. If the disk is one that is newly installed, the status of the drive will show up as Uninitialized.
3. Click the Init button.
4. A confirmation message, similar to the one shown in **Figure 193** will appear on the screen. Click OK to continue formatting process.

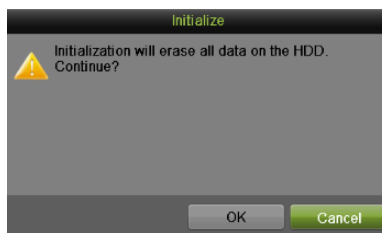

Figure 193 Disk Format Confirmation

5. A format progress bar will be shown on the menu. After the disk has been formatted, the status of the disk will change to Normal.

HDD Information									
Label	Capacity	Status	Property	Type	Free Space	Group	Edit	Delete	
5	931.51GB	Initializing 34%	R/W	Local	0MB	1	—	—	

Figure 194 Disk Format Progress Bar

Enabling HDD Overwrite

Enabling HDD overwrite will allow the DVR to overwrite the installed disks once the disks are full.

To enable HDD overwrite:

1. Enter the HDD menu by going to Menu > System Configuration > HDD.
2. Select the Record Information tab, as shown in **Figure 195**.



Figure 195 Record Information Menu

3. Check the Overwrite checkbox.
4. Click the Apply button.
5. Click  to exit.

Enabling HDD Sleeping mode

Enabling HDD sleeping mode will allow the HDD enter low power cost work mode when no recording work is detected.

To enable HDD sleeping mode:

1. Enter the HDD menu by going to Menu > System Configuration > HDD.
2. Select the Record Information tab, as shown in **Figure 195**.
3. Check the Enable HDD Sleeping checkbox.
4. Click the Apply button.
5. Click  to exit.

Enabling eSATA Auto Archive

Enabling eSATA Auto Archive will allow DVR automatically backup record files on external eSATA devices according to a preset schedule.

To enable eSATA Auto Archive:

1. Enter the HDD menu by going to Menu > System Configuration > HDD.
2. Select the Record Information tab, as shown in **Figure 195**.
3. Click on Setting button, as shown below.

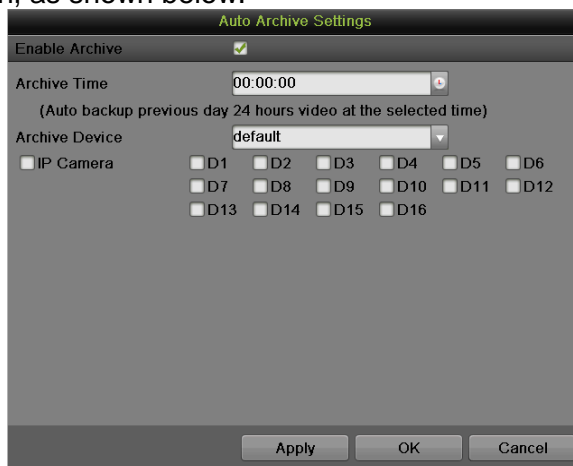



Figure 196 Auto Archive Settings Menu

4. Check the Enable Archive checkbox.
5. Set the Archive Time.
6. Check the channels needed to be backup.
7. Click Apply button.
8. Click  to exit.

Managing eSATA

When there is an external eSATA device connected to DVR, you can configure eSATA for the use of Record/Capture or Export. To manage eSATA:

1. Enter the HDD menu by going to Menu > System Configuration > HDD.
2. Select the Record Information tab, as shown in **Figure 195**.
3. Select the eSATA Usage to Record/Capture or Export from the dropdown list.
 - **Export:** Use the eSATA for backup.
 - **Record/Capture:** Use the eSATA for record/capture.
4. Click the Apply button to save the settings.

Configuring Quota Mode

Each camera can be configured with allocated quota for record or picture capture.

To configure quota mode:

1. Enter the quota mode menu by going to Menu > System Configuration > HDD.
2. Select the Storage Mode tab, as shown in **Figure 197**.

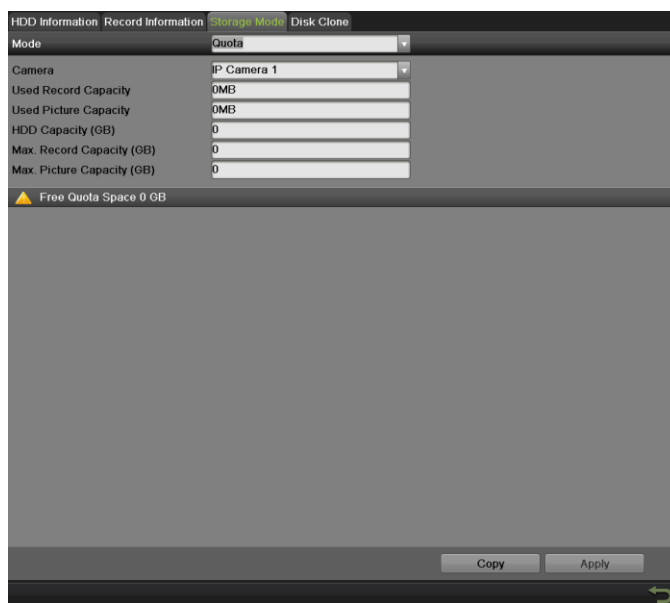

Figure 197 Quota Mode Settings Menu

3. Select the Mode to Quota.
4. Select a camera for which you want to configure quota.
5. Enter the storage capacity in the text fields of Max. Record Capacity (GB) and Max. Picture Capacity (GB).
6. If the same settings can be applied in other channels, click Copy.
7. Click the Apply button to save the settings.

Note:

If the quota capacity is set to 0, then all cameras will use the total capacity of HDD for record and picture capture.

Managing HDD Group

Multiple HDDs can be managed in groups. Video from specified channels can be recorded onto a particular HDD group through HDD settings. To managing HDD Group:

1. Enter the HDD menu by going to Menu > System Configuration > HDD.
2. Select the Storage Mode tab, as shown in **Figure 197**.
3. Select the Mode to Group, as show in **Figure 198**.

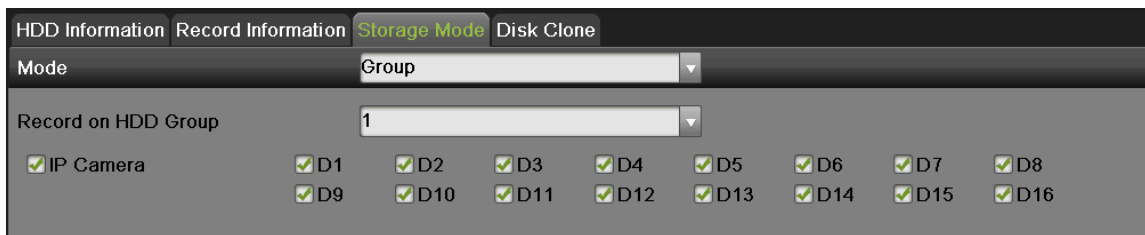

Figure 198 Group Mode Settings Menu

4. Click the Apply button to pop up an attention box as shown below:

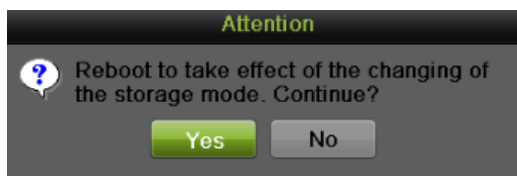



Figure 199 Attention for reboot

5. Click Yes to reboot and make the settings effective. Click No to cancel the operation.
6. After rebooting, you can configure local HDD settings. To configure local HDD settings by going to Menu > System Configuration > HDD > HDD Information.
 - 1) Select a HDD and click  to pop up the Local HDD Settings menu as shown in **Figure 200**.

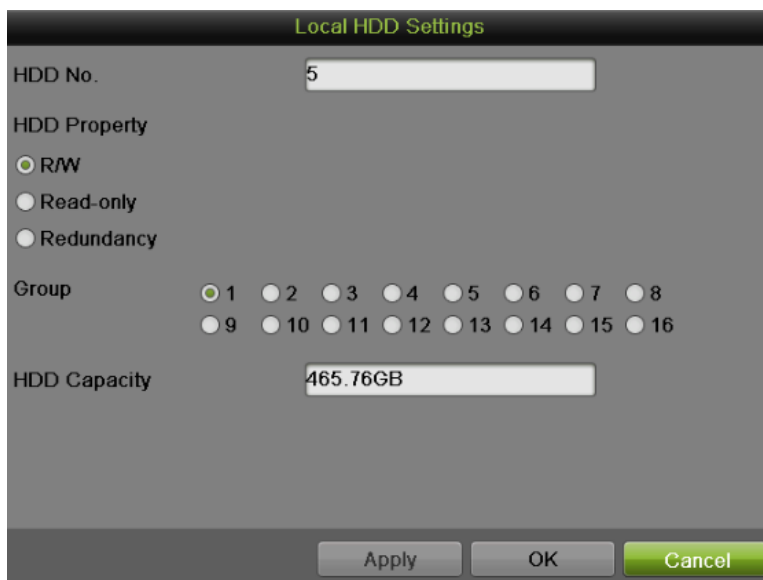

Figure 200 Local HDD Settings

- 2) Select the HDD Property from R/W, Read-only and Redundancy. Read-only mode can prevent important recorded files from being overwritten when the HDD becomes full in overwrite recording mode. Redundancy mode can ensure high security and

reliability by recording the video onto the redundancy HDD and R/W HDD simultaneously.

- 3) Select the Group number for the current HDD. The default group number for each HDD is 1.
- 4) Click the Apply button to save the settings and click OK to the up level menu.

Note:

At least 2 hard disks must be installed when you want to set a HDD to Redundancy mode and one of them with R/W property.

Disk Clone

Internal HDDs can be backup to external eSATA HDDs intact using this function. To clone HDD:

1. Enter the HDD menu by going to Menu > System Configuration > HDD.
2. Select the Disk Clone tab, as shown in **Figure 201**.

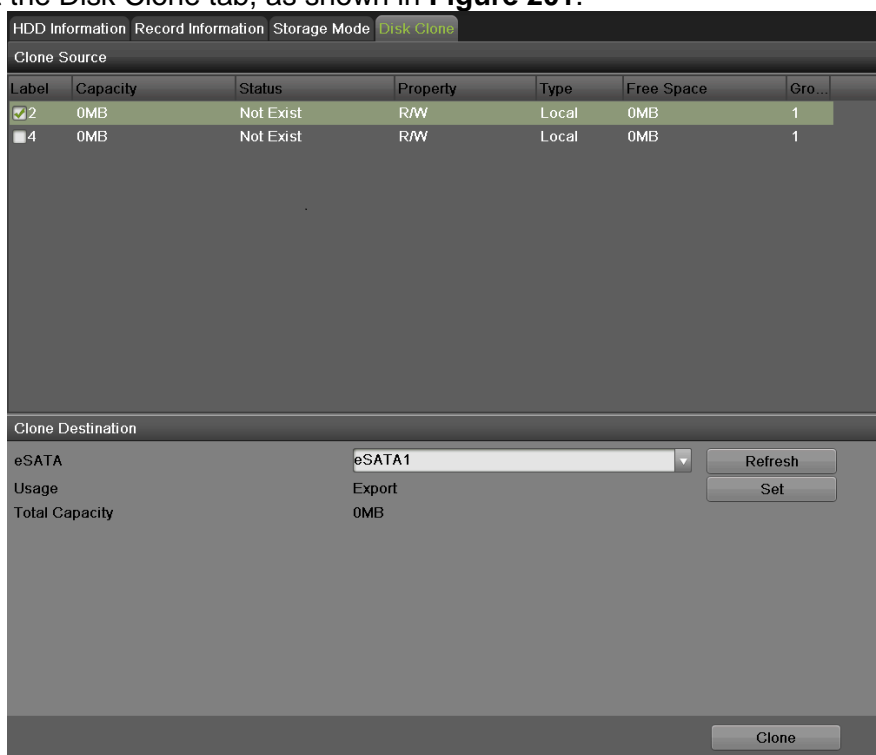

Figure 201 Local HDD Settings

3. Select the Clone Source by checking the box.
4. Select the Clone Destination by choosing the eSATA devices, and set the Usage of devices as Export.
5. Click Clone button to launch the clone process.

Note:

The storage volume of clone source and clone destination should be identical, otherwise the clone cannot be executed.

HDD Detect

The device provides the HDD detection function such as the adopting of the S.M.A.R.T. and the Bad Sector Detection technique.

S.M.A.R.T

The S.M.A.R.T. (Self-Monitoring, Analysis and Reporting Technology) is a monitoring system for HDD to detect and report on various indicators of reliability in the hopes of anticipation failures.



Figure 202 S.M.A.R.T. Settings Interface

To viewing S.M.A.R.T. information:

1. Enter the S.M.A.R.T. Settings menu by going to Menu > System Maintenance > HDD Detect.
2. Select the S.M.A.R.T. Settings tab, as shown in **Figure 202**.
3. Select a HDD to view its S.M.A.R.T. information list.
4. You can choose the Self-test Type from the dropdown list, including Short Test, Expanded Test and Conveyance Test.
5. Click the Test button to start the S.M.A.R.T. HDD self-evaluation.

Note:

If you want to use the HDD even when the S.M.A.R.T. checking is failed, you can check the checkbox of the Continue to use this disk when self-evaluation is failed item.

Bad Sector Detection

1. Enter the Bad Sector Detection menu by going to Menu > System Maintenance > HDD Detect.
2. Select the Bad Sector Detection tab, as shown in **Figure 203**.

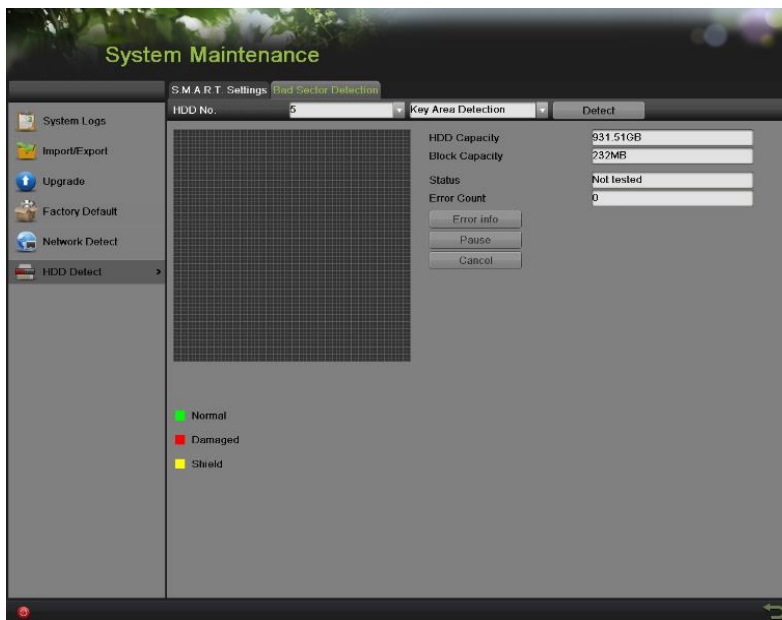

Figure 203 Bad Sector Detection Interface

3. Select the HDD you want to configure in the dropdown list.
4. Choose Key Area Detection or All Detection.
5. Click the Detect button to start the detection.
6. Click the Pause/Cancel button to pause/cancel at any time you want.
7. If the HDD is normal you can see the green color icon on the screen, while red means damaged and yellow means shield.
8. Click the Error Info to see the detail damage or shield information.

Managing Files

Searching for Recorded Files

Previously recorded files can be searched by criteria in the File Management menu.

To search for all recorded files:

1. Enter the File Management menu, shown in **Figure 204** by going to Menu > File Management> Record.



Figure 204 File Search Menu

2. Select the cameras that you would like to include in the search. Analog cameras are listed on the first row, preceded with the letter A. If you would like include all analog cameras in the search, check the Analog checkbox. Digital cameras are listed on the second row, preceded with the letter D. If you would like include all IP cameras in the search, check the IP Camera checkbox.
3. Select the Video Type. Video type includes Continuous, Event, Manual and All.
4. Select the File Type. File type includes Locked, Unlocked and All files.
5. Select the start time and the end time.
6. Click the Search button. A search result box will pop-up, as shown in **Figure 205**.
7. A list of results with your search criteria will be shown at the bottom of the menu.

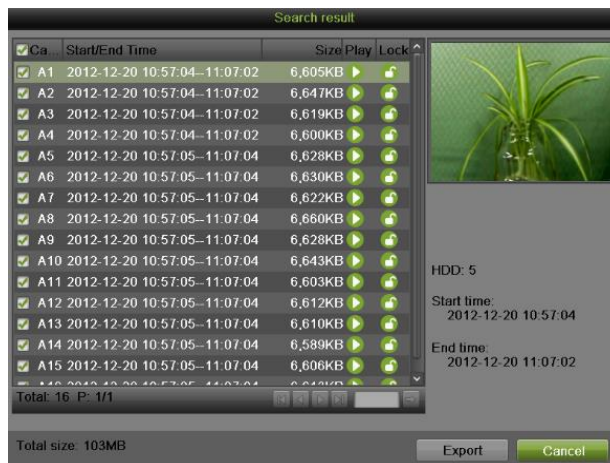

Figure 205 Search Result Interface

8. You may now play the selected file by clicking the Play button next to the file.
9. The recorded files can also be exported into a USB storage device. To export recorded files, connect a USB storage device to the DVR, select the record files to export and click the Export button.
10. Click the Cancel button to exit out of the File Management menu.

Searching for Event Files

Event recorded files can be searched by criteria in the File Management menu.

To search for all recorded Event files:

1. Enter the File Management menu by going to Menu > File Management> Event.



Figure 206 Event Search

2. Select the Event Type you want to search. File type includes Alarm Input and Motion files.
 - If you select type Motion:
 - 1) First you need to choose the cameras that you would like to include in the search. Analog cameras are listed on the first row, preceded with the letter A. If you would like include all analog cameras in the search, check the Analog checkbox. IP cameras are listed on the second row, preceded with the letter D. If you would like include all IP cameras in the search, check the IP Camera checkbox.
 - 2) Select the start time and the end time.
 - 3) Click the Search button.
 - 4) A list of results with your search criteria will be shown at a pop-up box.
 - 5) You can set the Pre-play and
 - 6) Post-play time.
 - 7) Select one result to see the details by clicking Details button or quick export by clicking the Quick Export button
 - If you select type Alarm Input:
 - 1) First you select one alarm input channel or you can check the Alarm Input No. box to select all channels.
 - 2) Select the start time and the end time.
 - 3) Click the Search button.
 - 4) A list of results with your search criteria will be shown at a pop-up box, and you can select record to do proper settings.

Searching for Captured Picture

Search and view captured pictures stored in HDD.

To search for all captured pictures:

1. Enter the File Management menu by going to Menu > File Management> Picture.
2. Select channel, picture type.
3. Select start time and stop time.
4. Click Search button to enter Search Result interface.
5. Left-click to view the picture.



Figure 207 Picture Search

Searching for POS event files

Search and view POS events stored in HDD.

To search for specified POS events:

1. Enter File Management menu by going to Menu>File Management>POS.

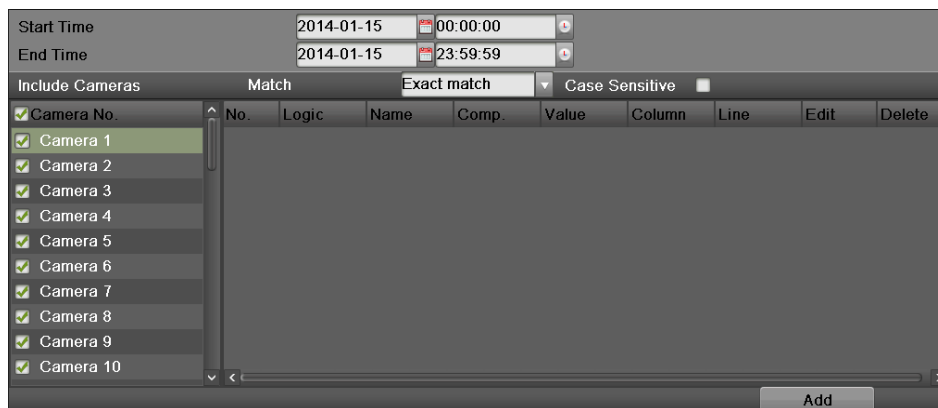

Figure 208 POS events

- a. Click the Include Cameras check box to select the channels
- b. Set the search time (Start Time and End Time)
- c. Select the Match mode during video search: Exact match, Approximate match, Event Flag match and Guide match.

Exact match

- 1) Click to select Exact match, and then click button Add to add POS video records search condition interface as follows.

- 2) When you set multiple conditions, these settings will be displayed in the windows. The search results will all fit the settings listed.

No.	Logic	Name	Comp.	Value	Column	Line	Edit	Delete
1	OR	1	<	0.00	1	0		
2	AND	2	>	0.00	1	0		
3	AND	3	>	0.00	1	0		
4	AND	4	>	0.00	1	0		
5	AND	5	>	0.00	1	0		
6	AND	6	>	0.00	1	0		
7	AND	7	>	0.00	1	0		
8	AND	8	>	0.00	1	0		

Approximate match

Click to select Approximate match, and then type in the keywords you want to search. The search results are the record POS files that contain the keywords. When multiple keywords are typed in, POS files with only one of the keywords will also be displayed.

Event Flag match

Click to select Event Flag match, and then type in the attributes of the POS Events you want to be searched, including the Filter, Event Flag, Acknowledge and Notes.



The screenshot shows a configuration window titled 'Match' with a dropdown menu set to 'Event Flag match' and a 'Case Sensitive' checkbox. The window contains the following fields:

- Enable filter search:
- Filter Keyword:
- Event Flag: (dropdown menu is open showing options: No Flag, Valid, Investigate, Suspect, All)
- Acknowledge:
- Notes:

Guide match

Click to select Guide match, and then check the boxes according to which kinds of criterion when do searching, like item name, total, etc.

The POS records matching all or one of these criterion (depends on logic choice: AND means all, and OR means one of them) will be displayed.

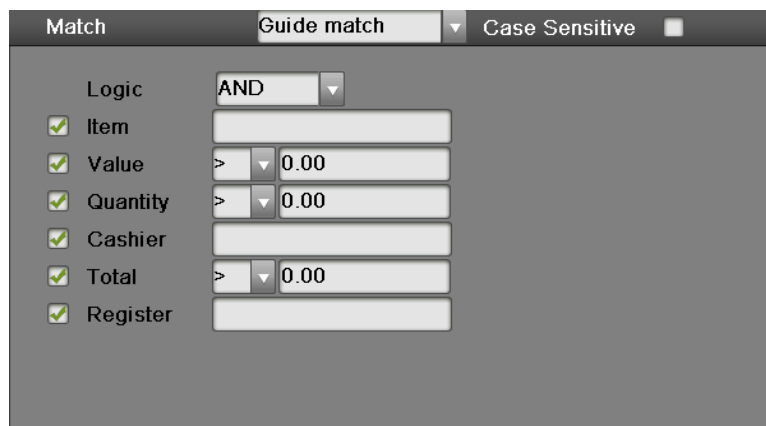

The screenshot shows a configuration window titled 'Match' with a dropdown menu set to 'Guide match' and a 'Case Sensitive' checkbox. The window contains the following fields:

- Logic: (dropdown menu)
- Item:
- Value: (dropdown menu)
- Quantity: (dropdown menu)
- Cashier:
- Total: (dropdown menu)
- Register:

d. The search result will show like the interface below.

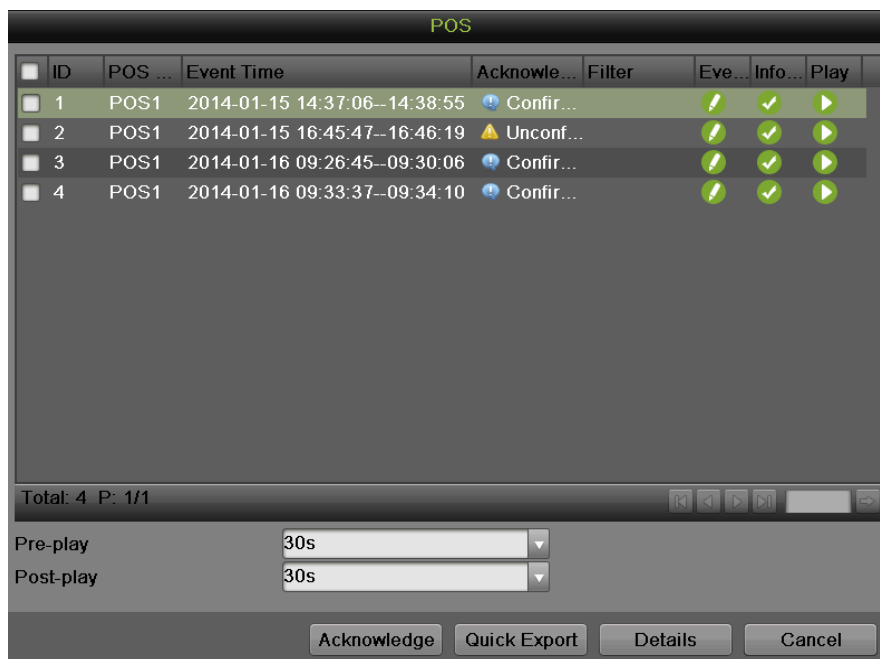



Figure 209 POS search result

1) All results not confirmed will be marked with yellow mark , once you have confirmed the records, you can click on this mark, and it will turn into , which means this incident has been confirmed.

2) Click on Event Flag , the following window will pop up:



Figure 210 POS event flag

Click on Event Flag to choose kind of Flag which indicates the attribute of this POS record. You can also leave notes in Notes box, which can be searched by keywords in file management system and playback feature.

- 3) Double click on selected event bar, detailed POS transaction information will show in a pop-up window, as shown below.

POS Information

POS Source: POS1

Start Time: 2014-01-16 09:38:06

End Time: 2014-01-16 09:38:38

Information:

With us, it's personal.
Store #05603
UP TO 30 DAYS
REFUNDS/EXCHANGES
2797 S. DIAMOND BAR
BLVD.
OIAMONO BAR, CA 91765
(909) 595-0912
Register #7 Transaction #648226
Cashier #8888 11/30/13 7:45PM
PA GLUCOSAMINE 500MG 60CT 2 110.99
COCACOLA COLA 400ML 20 114.99
DEFU CHOCOLATE 500G 12PC 1000 1199.00
HAAGEN DAZE 200MG 1TC 1000 9120.00

Previous Next OK

Figure 211 POS Information

Locking and Unlocking Recorded Files

To lock and unlock recorded files:

1. Search for recorded files using the File Management menu.
2. Select the file you would like to lock/unlock.
3. Click the Lock icon for the selected file.

Note:

Locked files will never be overwritten until they are unlocked.

CHAPTER 12 DVR Management

Managing System

Upgrading the System Firmware

The system firmware for your DVR can be updated from a USB storage device or FTP. To update the system firmware from a USB storage device:

1. Enter the Upgrade menu by going to Menu > Maintenance > Upgrade.
2. Select the Local Upgrade tab, as shown in **Figure 212**.

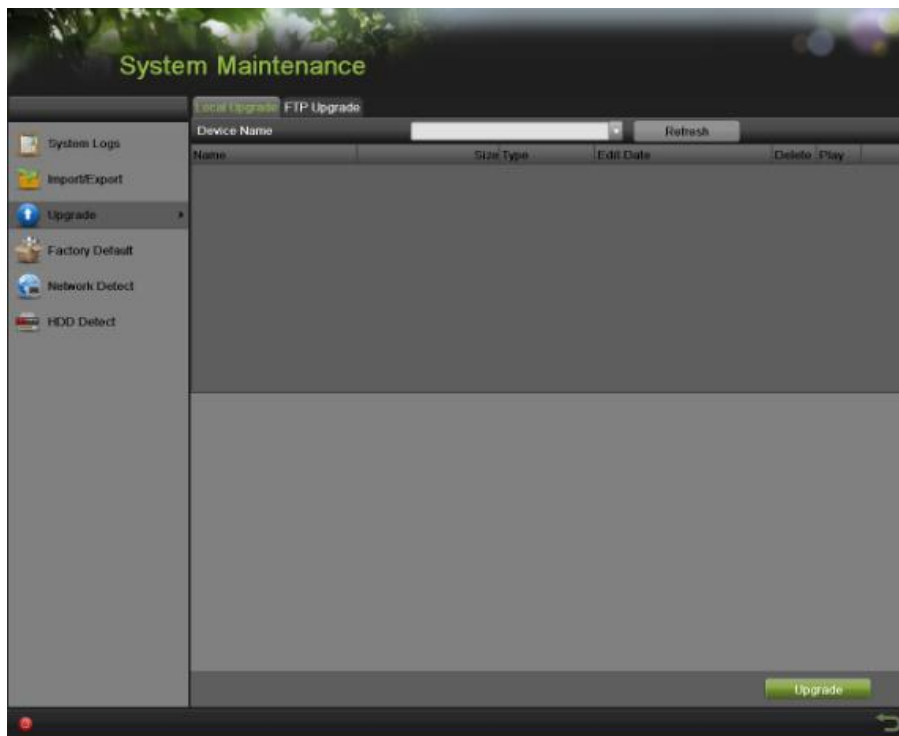

Figure 212 Local Upgrade Menu

3. Connect the USB storage device to a USB port on the DVR.
4. Click the Refresh button. The contents of the USB storage device will be shown on the screen.
5. Select the firmware file. The firmware file is named digicap.mav.
6. Click the Upgrade button to upgrade the DVR. The DVR will automatically reboot after the upgrade is completed. If you do not wish to upgrade at this point, click the Cancel button.

To update the system firmware from FTP:

1. Enter the Upgrade menu by going to Menu > Maintenance > Upgrade.
2. Select the FTP Upgrade tab, as shown in **Figure 213**.

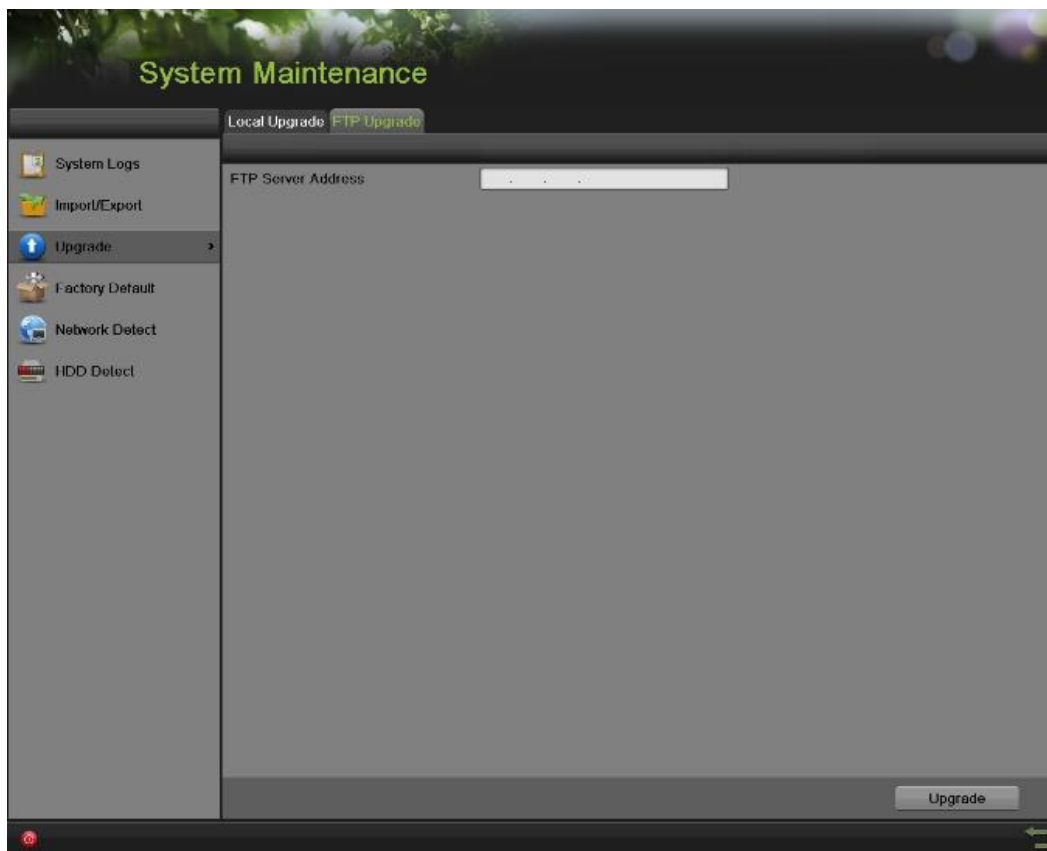

Figure 213 FTP Upgrade Menu

3. Enter the FTP Server Address.
4. Click the Upgrade button to upgrade the DVR. The DVR will automatically reboot after the upgrade is completed.

Restoring Default Settings

To restore factory default settings to your DVR:

1. Enter the Factory Default menu, shown in **Figure 214** by going to Menu > Maintenance > Factory Default.

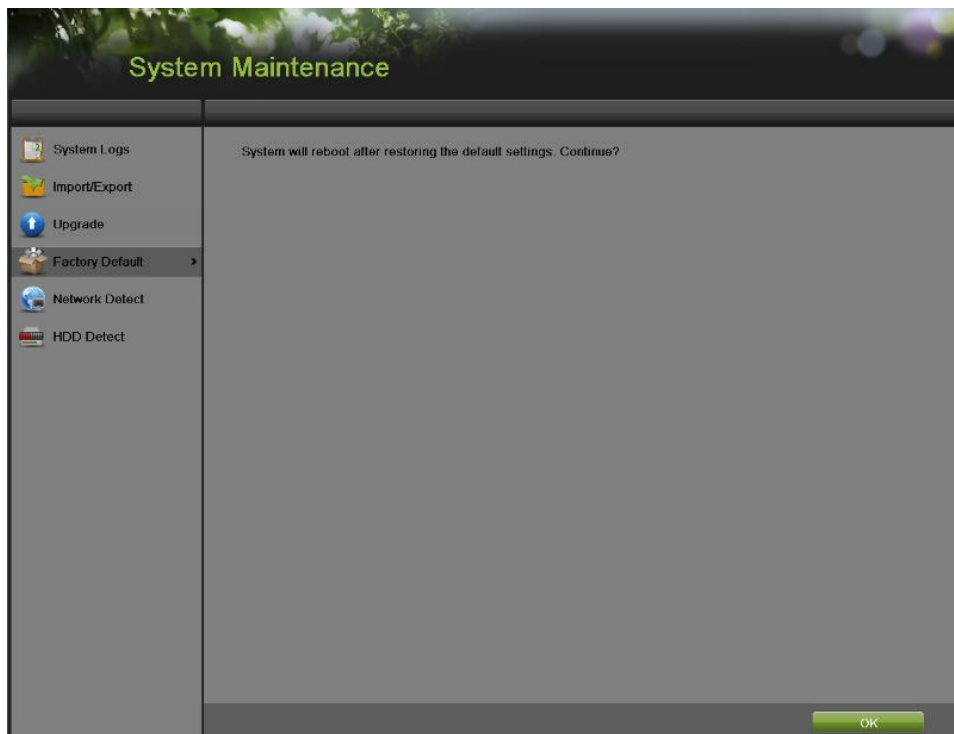



Figure 214 Factory Default Menu

-
2. Select the OK button to restore factory defaults or select  to return to the previous menu.

Note:

Network information such as IP address, subnet mask and gateway will not be restored.

Exporting & Importing Configuration

Configuration information from your DVR can be exported to a USB storage device and imported into another DVR. This will allow you to efficiently setup the same configuration on numerous DVRs.

To export DVR configuration:

1. Enter the Import/Export menu, shown in **Figure 215** by going to Menu > Maintenance > Import/Export.

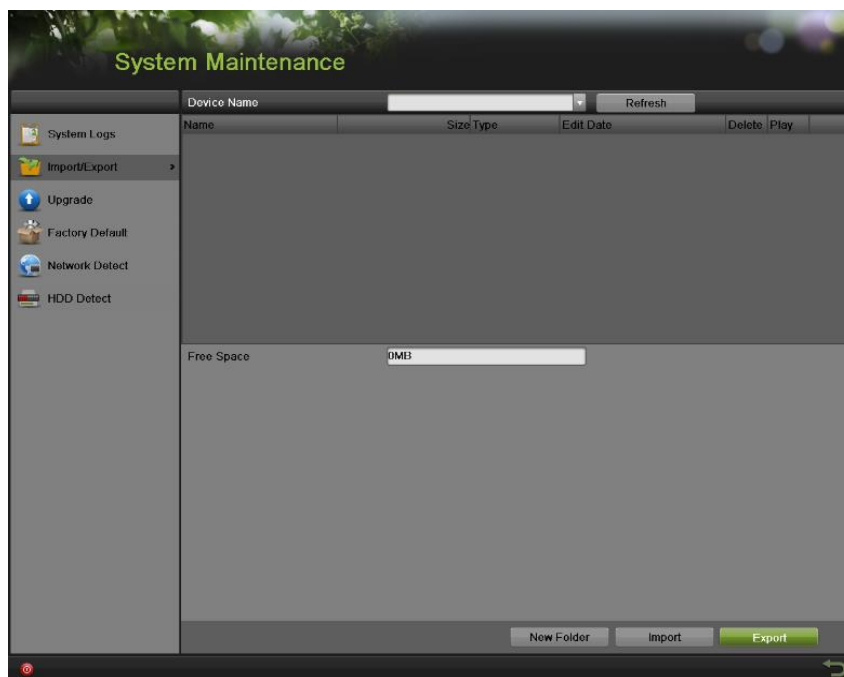



Figure 215 Import/Export Menu

2. Connect the USB storage device to a USB port on the DVR.
 3. Click the Refresh button. The contents of the USB storage device will be shown on the screen.
 4. You can click the New Folder button to create a new folder.
 5. Select the location where you would like the configuration to be stored on the USB storage device.
 6. Click Export to export a configuration file to USB storage device. The configuration file will be named devCfg.bin.
- Click  to exit out of the Import / Export menu.

To import DVR configuration:

1. Enter the Import/Export menu, shown in **Figure 215** by going to Menu > Maintenance > Import/Export.
2. Connect the USB storage device to a USB port on the DVR.
3. Click the Refresh button. The contents of the USB storage device will be shown on the screen.
4. Select the configuration file. The configuration file is named devCfg.bin.
5. Click the Import button.

6. In the pop-up window click Yes to confirm the import and the system will automatically reboot to make it effective
7. Click  to exit out of the Import/Export menu.

Viewing System Logs

Many events of your DVR are logged into the system logs. To access the system logs and search for these events:

1. Enter the System Logs menu, shown in **Figure 216** by going to Menu > Maintenance > System Logs.

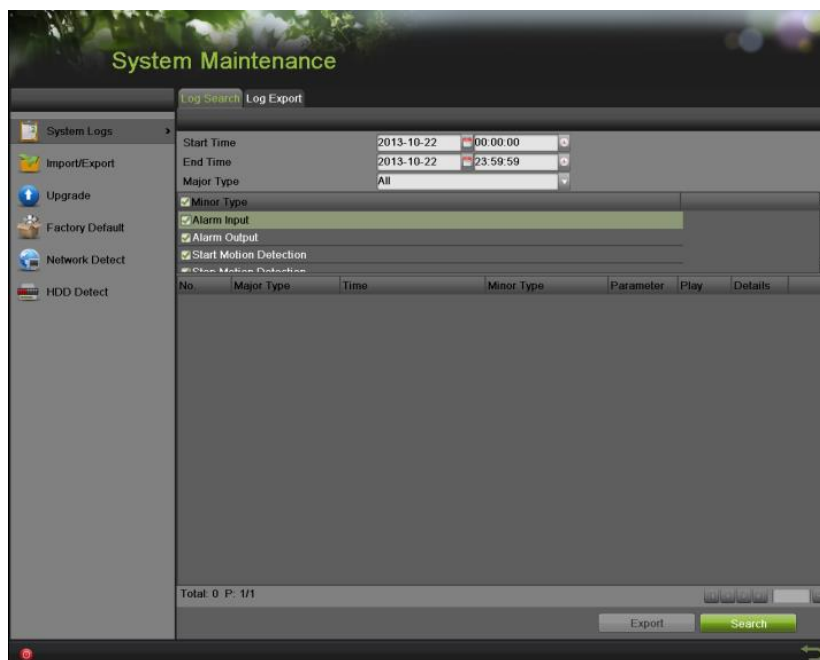



Figure 216 System Logs Menu

2. Select the Start Time and the End Time.
3. Select the Major Type from the dropdown list. Four major types are available: Alarm, Exception, Operation and Information. You can also select All.
4. Select the Minor Type under the Major Type to efficiently find the logs.
5. Click the Search button. The search results will be displayed in a list (**Figure 217**). Click  to page up and down.

Note:

Up to 2000 log files can be displayed each time.

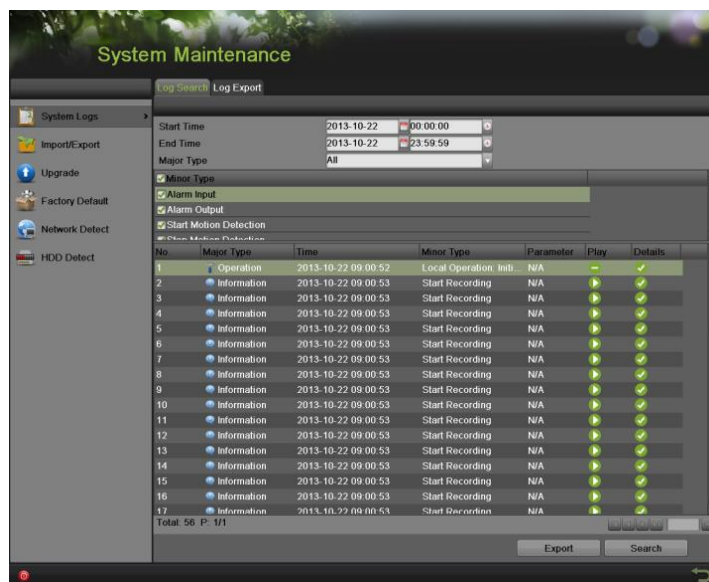



Figure 217 Log Search Results

6. Click  under the Detail item to view the detail information, as shown in **Figure 218**.

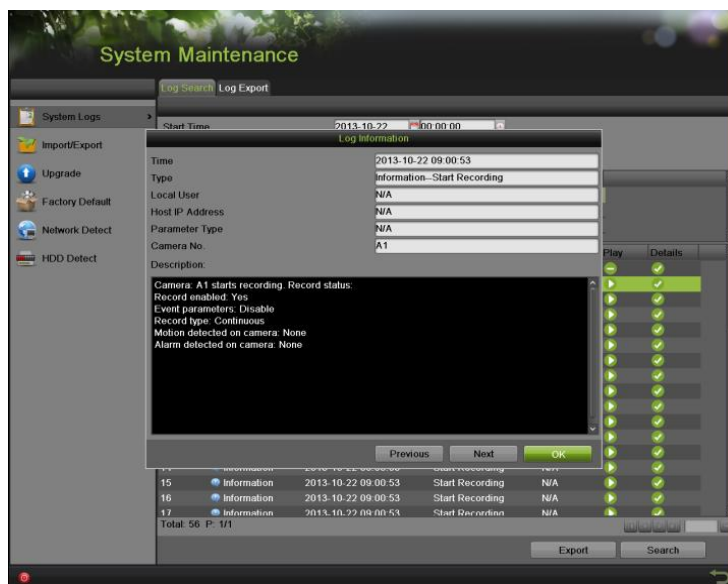



Figure 218 Log Information

7. Click Previous/Next to view the previous/next log information.
8. Click OK to back to the previous menu.
9. If applicable, you may also view the associated video to the selected log entry by clicking .
10. Log files can also be exported onto a USB storage device. To export a log file, connect a USB storage device to the DVR, select the log files to export and click the Export button.
11. Click  to exit out of menu.

Network detection

You can view the network traffic to obtain real-time information and connecting status of your DVR.

To view network traffic:

1. Enter the Network Detection menu by going to Menu > System Maintenance > Network Detection.
2. Select the Traffic tab and you can view the sending rate and receiving rate information on the interface, as shown in **Figure 219**. The traffic data is refreshed every 1 second.



Figure 219 Traffic Detection

To configure network detection:

1. Enter the Network Detection menu by going to Menu > Maintenance > Network Detection.
2. Select the Network Detection tab to enter the Network Detection menu, as shown in **Figure 220**.

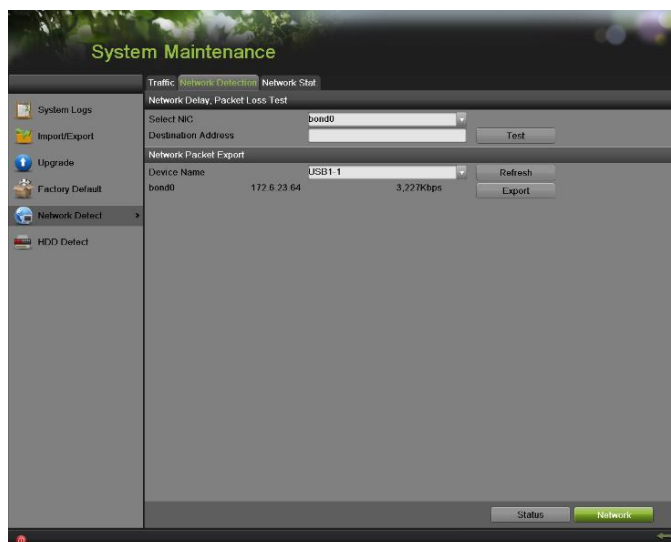

Figure 220 Network Detection

3. Enter the destination address in the text field of Destination Address.
4. Click the Test button to start testing network average delay and packet loss rate. The testing result will pop up on the window.
5. Click the Status to check the network status.

To export network packet:

By connecting the DVR to network, the captured network data packet can be exported to USB-flash disk, SATA/eSATA CD-RW and other local backup devices.

1. Enter the Network Detection menu by going to Menu > Maintenance > Network Detection.
2. Select the Network Detection tab to enter the Network Detection menu.
3. Click the Export button to start exporting.
4. After the exporting is complete, click OK to finish the packet export, as shown in **Figure 221**.

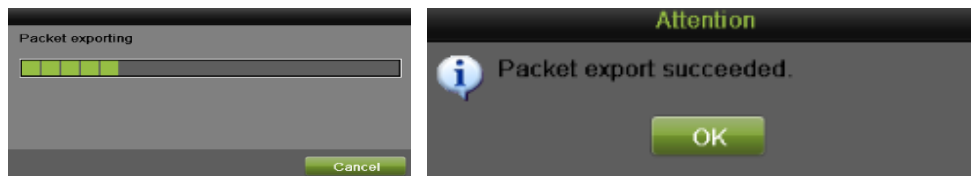

Figure 221 Export Process Bar

Note:

Click the Refresh button if the connected local backup device cannot be displayed. When it fails to detect the backup device, please check whether it is compatible with the DVR. You can format the backup device if the format is incorrect.

To view network status:

1. Enter the Network Stat. menu by going to Menu > Maintenance > Network Detection.
2. Select the Network Stat. tab to enter the Network Stat. menu, as shown in **Figure 222**.

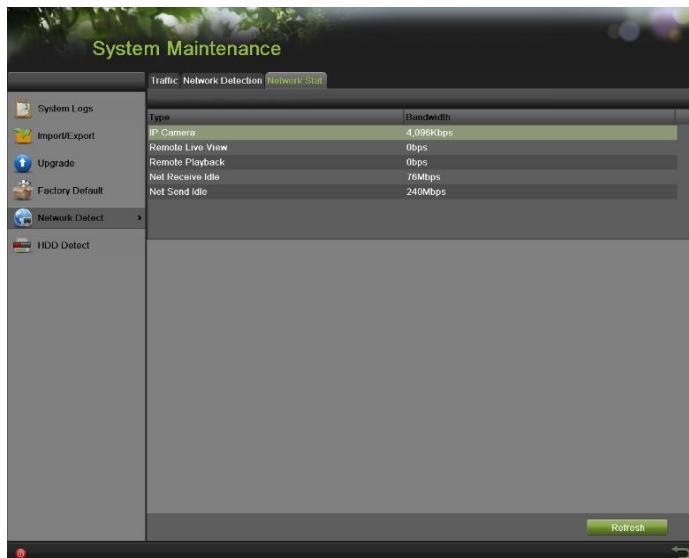

Figure 222 Network Stat. Interface

3. Check the bandwidth of IP Camera, Remote Live View, Remote Playback, Net Receive Idle and Net Send Idle.
4. You can click the Refresh button to get the latest status.